

Złączki tradycyjne

Tradycyjne rozwiązania połączeń, dla każdego zastosowania

ZASTOSOWANIE

| Technologia | Oferta COMAP | Rury | Sanitarne | Gaz | Ogrzewania | Chłodzenie | Podłogowe |
|-------------|--------------|----------------|-----------|-----|------------|------------|-----------|
| zaciskowe | TurboSKIN | wielowarstwowe | ○ | | ○ | ○ | ○ |
| zaciskowe | Jevco | miedź | ○ | | ○ | ○ | |
| lutowanie | SUDO Miedź | miedź | ○ | ○ | ○ | ○ | |
| lutowanie | SUDO Mosiądz | miedź | ○ | | ○ | ○ | |
| lutowanie | SUDO Brąz | miedź | ○ | | ○ | ○ | |

Oferujemy szeroki zakres tradycyjnych złączy do instalacji z rur wielowarstwowych, PEX i miedzianych. Są dostępne w różnych technologiach wykonywania połączeń: złączki zaciskowe, skręcane i do lutowania.

JAKOŚĆ I NIEZAWODNOŚĆ

DOŚWIADCZENIE: Ponad 60 lat doświadczenia firmy COMAP w produkcji złączy do budowy instalacji.

NAJWYŻSZA JAKOŚĆ: Do produkcji naszych złączy używamy tylko najwyższej jakości surowców.

APROBATY: Nasze złączki posiadają najważniejsze europejskie certyfikaty.

DUŻA RODZINA: COMAP oferuje 7 różnych gam produktów, mając rozwiązania dla każdego przypadku.

Złączki zaciskowe (skręcane)

130

Złączki SUDO do lutowania

142

ZŁĄCZKI ZACISKOWE (SKRĘCANE)

COMAP oferuje szeroką gamę złączek dedykowaną różnym rodzajom rur:

- Złączki zaciskowe TurboSKIN są odpowiednie dla rur wielowarstwowych.
- Złączki zaciskowe SUDO (Jevco) są odpowiednie do rur miedzianych.



ZASTOSOWANIE

Złączki zaciskowe są demontowalne, dlatego nie mogą być montowane w elementach strukturalnych budynku (w ścianach albo w podłodze). Złączki takie można montować w widocznych i dostępnych miejscach. Nadają się do nowych instalacji i renowacji.

Złączki zaciskowe powinny być stosowane tylko z rurami PEX, wielowarstwowymi produkcji COMAP i miedzianymi zgodnymi z EN 1057 (według tabeli poniżej).

| technologia | gama Comap | rury | sanitarne | gaz | ogrzewanie | chłodzenie | ogrzewanie podłogowe |
|-------------|------------|----------------|-----------|-----|------------|------------|----------------------|
| zaciskowe | TurboSKIN | wielowarstwowe | ● | - | ● | ● | ● |
| zaciskowe | Jevco | miedź | ● | - | ● | ● | |



WYPRODUKOWANE
W EUROPIE

ZALETY

- ŁATWE W UŻYCIU: Nie potrzeba żadnych specyficznych narzędzi, jedynie typowe klucze płaskie.
- WSZECHSTRONNE: Nadają się do każdej naprawy instalacji.

CECHY

- TurboSKIN
 - złączki zaciskowe z mosiądzu o średnicach od 14 do 32 mm.
 - wysokiej jakości uszczelka o-ring z EPDM.
- SUDO zaciskowe (Jevco)
 - złączki zaciskowe z brązu o średnicach od 10 do 54 mm.
 - zgodne z normami EN 1254-1.

Certyfikaty:



tylko TurboPEX i TurboSKIN



tylko SUDO zaciskowe

ZŁĄCZKA PROSTA, ZACISK – GWINT ZEWNĘTRZNY

9460



| Wymiary | Kod produktu | Opak. |
|------------|--------------|-------|
| 14x2 - 1/2 | 9460164 | 10 |
| 16x2 - 1/2 | 9460314 | 10 |
| 16x2 - 3/4 | 9460316 | 10 |
| 18x2 - 1/2 | 9460404 | 10 |
| 18x2 - 3/4 | 9460406 | 10 |
| 20x2 - 1/2 | 9460514 | 10 |
| 20x2 - 3/4 | 9460516 | 10 |
| 26x3 - 3/4 | 9460786 | 5 |
| 26x3 - 1" | 9460788 | 5 |
| 32x3-1" | 9460968 | 5 |

ZŁĄCZKA PROSTA, ZACISK – ZACISK

9461



| Wymiary | Kod produktu | Opak. |
|---------|--------------|-------|
| 14x2 | 9461016 | 10 |
| 16x2 | 9461031 | 10 |
| 18x2 | 9461040 | 10 |
| 20x2 | 9461051 | 10 |
| 26x3 | 9461078 | 10 |
| 32x3 | 9461096 | 5 |

ZŁĄCZKA PROSTA, ZACISK – GWINT WEWNĘTRZNY

9462



| Wymiary | Kod produktu | Opak. |
|------------|--------------|-------|
| 14x2 - 1/2 | 9462164 | 10 |
| 16x2 - 1/2 | 9462314 | 10 |
| 16x2 - 3/4 | 9462316 | 10 |
| 18x2 - 1/2 | 9462404 | 10 |
| 18x2 - 3/4 | 9462406 | 10 |
| 20x2 - 1/2 | 9462514 | 10 |
| 20x2 - 3/4 | 9462516 | 10 |
| 26x3 - 3/4 | 9462786 | 5 |
| 26x3 - 1" | 9462788 | 5 |
| 32x3 - 1" | 9462968 | 5 |

 **PRODUKTY POWIĄZANE**

RURY WIELOWARSTWOWE

Twój system będzie kompletny gdy dobierzesz rury wielowarstwowe z oferty COMAP.



Gama MultiSKIN: Średnice od 14 do 63 mm. Wyprodukowane z PEX/Al, z mocnym aluminiowym rdzeniem dla większej wytrzymałości na wysokie temperatury i ciśnienia.

Gama BetaSKIN: Średnice od 14 do 32 mm. Wyprodukowane z PE-RT/Al, z lekkim aluminiowym rdzeniem, dla większej elastyczności.

Te rury są zgodne z normami EN ISO 21003 i dostępne są w sztangach, zwojach, w izolacji i w ochronnej rurze karbowanej.

| | |
|----------------|-----|
| Rury MultiSKIN | 102 |
| Rury BetaSKIN | 108 |

KOLANO 90°, ZACISK – ZACISK

9463



| Wymiary | Kod produktu | Opak. |
|---------|--------------|-------|
| 14x2 | 9463016 | 10 |
| 16x2 | 9463031 | 10 |
| 18x2 | 9463040 | 10 |
| 20x2 | 9463051 | 10 |
| 26x3 | 9463078 | 5 |
| 32x3 | 9463096 | 5 |

KOLANO 90°, ZACISK – GWINT ZEWNĘTRZNY

9464



| Wymiary | Kod produktu | Opak. |
|------------|--------------|-------|
| 16x2 - 1/2 | 9464314 | 10 |
| 16x2 - 3/4 | 9464316 | 10 |
| 18x2 - 1/2 | 9464404 | 10 |
| 20x2 - 1/2 | 9464514 | 10 |
| 20x2 - 3/4 | 9464516 | 10 |
| 26x3 - 3/4 | 9464786 | 5 |
| 26x3 - 1" | 9464788 | 5 |
| 32x3 - 1" | 9464968 | 5 |

KOLANO 90°, ZACISK – GWINT WEWNĘTRZNY

9465



| Wymiary | Kod produktu | Opak. |
|------------|--------------|-------|
| 16x2 - 1/2 | 9465314 | 10 |
| 16x2 - 3/4 | 9465316 | 10 |
| 18x2 - 1/2 | 9465404 | 10 |
| 20x2 - 1/2 | 9465514 | 10 |
| 20x2 - 3/4 | 9465516 | 10 |
| 26x3 - 3/4 | 9465786 | 5 |
| 26x3 - 1" | 9465788 | 5 |
| 32x3 - 1" | 9465968 | 5 |

KOLANO Z ŁAPAMI, ZACISK – GWINT WEWNĘTRZNY

9466



| Wymiary | Kod produktu | Opak. |
|------------|--------------|-------|
| 14x2 - 1/2 | 9466164 | 10 |
| 16x2 - 1/2 | 9466314 | 10 |
| 18x2 - 1/2 | 9466404 | 10 |
| 20x2 - 1/2 | 9466514 | 10 |
| 20x2 - 3/4 | 9466516 | 10 |

TRÓJNIK ZACISKOWY

9467



| Wymiary | Kod produktu | Opak. |
|---------|--------------|-------|
| 14x2 | 9467016 | 10 |
| 16x2 | 9467031 | 10 |
| 18x2 | 9467040 | 10 |
| 20x2 | 9467051 | 10 |
| 26x3 | 9467078 | 5 |
| 32x3 | 9467096 | 5 |

TRÓJNIK, GWINT ZEWNĘTRZNY – ZACISK

9468



| Wymiary | Kod produktu | Opak. |
|------------|--------------|-------|
| 16x2 - 1/2 | 9468314 | 10 |
| 20x2 - 1/2 | 9468514 | 10 |
| 20x2 - 3/4 | 9468516 | 10 |
| 26x3 - 1/2 | 9468784 | 5 |
| 26x3 - 3/4 | 9468786 | 5 |
| 26x3 - 1" | 9468788 | 5 |
| 32x3 - 1" | 9468968 | 5 |

TRÓJNIK, GWINT WEWNĘTRZNY – ZACISK

9469



| Wymiary | Kod produktu | Opak. |
|------------|--------------|-------|
| 16x2 - 1/2 | 9469314 | 10 |
| 18x2 - 1/2 | 9469404 | 10 |
| 20x2 - 1/2 | 9469514 | 10 |
| 20x2 - 3/4 | 9469516 | 10 |
| 26x3 - 3/4 | 9469786 | 5 |
| 26x3 - 1" | 9469788 | 5 |
| 32x3 - 1" | 9469968 | 5 |

TRÓJNIK ZACISKOWY, REDUKCYJNY

9467R



| Wymiary (S1-S2-S3) | Kod produktu | Opak. |
|--------------------|--------------|-------|
| 20x2 - 16x2 - 16x2 | 9467513131 | 10 |
| 20x2 - 16x2 - 20x2 | 9467513151 | 10 |
| 20x2 - 20x2 - 16x2 | 9467515131 | 10 |
| 26x3 - 16x2 - 26x3 | 9467783178 | 5 |
| 26x3 - 20x2 - 20x2 | 9467785151 | 10 |
| 26x3 - 20x2 - 26x3 | 9467785178 | 5 |
| 26x3 - 26x3 - 20x2 | 9467787851 | 5 |
| 32x3 - 26x3 - 32x3 | 9467967896 | 5 |

REDUKCJA, ZACISK – ZACISK

9461R



| Wymiary | Kod produktu | Opak. |
|-------------|--------------|-------|
| 18x2 - 16x2 | 94614031 | 10 |
| 20x2 - 16x2 | 94615131 | 10 |
| 26x3 - 20x2 | 94617851 | 5 |

KOLANO Z ŁAPAMI PODWÓJNE, ZACISK – GWINT ZEWN.

9466D



| Wymiary | Kod produktu | Opak. |
|-------------------|--------------|-------|
| 16x2 - 1/2 - 16x2 | 946631431 | 10 |

ZŁĄCZKA PROSTA ZACISK GWINT ZEWNĘTRZNY

J500



| Wymiary | Kod produktu | Opak. |
|----------|--------------|-------|
| 10-1/4 | 8500022 | 10 |
| 10-3/8 | 8500032 | 10 |
| 10-1/2 | 8500042 | 10 |
| 12-3/8 | 8500033 | 10 |
| 12-1/2 | 8500043 | 10 |
| 15-1/2 | 8500045 | 10 |
| 15-3/4 | 8500065 | 10 |
| 18-1/2 | 8500047 | 10 |
| 18-3/4 | 8500067 | 10 |
| 22-1/2 | 8500049 | 10 |
| 22-3/4 | 8500069 | 10 |
| 22-1" | 8500089 | 10 |
| 28-3/4 | 8500070 | 10 |
| 28-1" | 8500090 | 10 |
| 35-1 1/4 | 8600111 | 1 |
| 42-1 1/2 | 8600133 | 1 |
| 54-2" | 8600174 | 1 |

ZŁĄCZKA REDUKCYJNA ZACISK

J503R

zaciskana dwustronnie



| Wymiary | Kod produktu | Opak. |
|---------|--------------|-------|
| 12-10 | 8503032 | 10 |
| 22-15 | 8503095 | 10 |
| 28-22 | 8503109 | 10 |

ZŁĄCZKA PROSTA ZACISK GWINT WEWNĘTRZNY

J501



| Wymiary | Kod produktu | Opak. |
|----------|--------------|-------|
| 10-3/8 | 8501032 | 10 |
| 10-1/2 | 8501042 | 10 |
| 12-3/8 | 8501033 | 10 |
| 12-1/2 | 8501043 | 10 |
| 15-1/2 | 8501045 | 10 |
| 15-3/4 | 8501065 | 10 |
| 18-3/4 | 8501067 | 10 |
| 18-1/2 | 8501047 | 10 |
| 22-1/2 | 8501049 | 10 |
| 22-3/4 | 8501069 | 10 |
| 22-1" | 8501089 | 10 |
| 28-1" | 8501090 | 10 |
| 35-1 1/4 | 8601111 | 1 |
| 42-1 1/2 | 8601133 | 1 |

ZŁĄCZKA PROSTA ZACISK

J503

zaciskana dwustronnie



| Wymiary | Kod produktu | Opak. |
|---------|--------------|-------|
| 10 | 8503022 | 10 |
| 12 | 8503033 | 10 |
| 15 | 8503055 | 10 |
| 18 | 8503077 | 10 |
| 22 | 8503099 | 10 |
| 28 | 8503110 | 10 |
| 35 | 8603121 | 1 |
| 42 | 8603143 | 1 |
| 54 | 8603154 | 1 |

KOLANO 90° ZACISK GWINT ZEWNĘTRZNY

J507



| Wymiary | Kod produktu | Opak. |
|---------|--------------|-------|
| 10-1/2 | 8507042 | 10 |
| 12-3/8 | 8507033 | 10 |
| 12-1/2 | 8507043 | 10 |
| 15-1/2 | 8507045 | 10 |
| 18-1/2 | 8507047 | 10 |
| 18-3/4 | 8507067 | 10 |
| 22-3/4 | 8507069 | 10 |
| 28-1" | 8507090 | 10 |

KOLANO 90° ZACISK GWINT WEWNĘTRZNY

J509



| Wymiary | Kod produktu | Opak. |
|---------|--------------|-------|
| 12-1/2 | 8509043 | 10 |
| 15-1/2 | 8509045 | 10 |
| 18-1/2 | 8509047 | 10 |
| 18-3/4 | 8509067 | 10 |
| 22-1/2 | 8509049 | 10 |
| 22-3/4 | 8509069 | 10 |
| 28-1" | 8509090 | 10 |

KOLANO 90°

J512

obustronnie zaciskane



| Wymiary | Kod produktu | Opak. |
|---------|--------------|-------|
| 10 | 8512022 | 10 |
| 12 | 8512033 | 10 |
| 15 | 8512055 | 10 |
| 18 | 8512077 | 10 |
| 22 | 8512099 | 10 |
| 28 | 8512110 | 10 |
| 35 | 8612121 | 1 |
| 42 | 8612143 | 1 |
| 54 | 8612154 | 1 |

KOLANO 90° REDUKCYJNE

J512R

obustronnie zaciskane



| Wymiary | Kod produktu | Opak. |
|---------|--------------|-------|
| 22-15 | 8512095 | 10 |
| 28-22 | 8512109 | 10 |

KOLANO Z ŁAPAMI

J510

montaż trzema wkrętami



| Wymiary | Kod produktu | Opak. |
|---------|--------------|-------|
| 12-1/2 | 8510043 | 10 |
| 15-1/2 | 8510045 | 10 |

* UWAGA

TULEJA WZMACNIAJĄCA SUDO (JEVCO)



Podczas montażu złączek zaciskowych SUDO (Jevco) na rurze z miedzi miękkiej, należy wzmocnić ją tuleją wzmacniającą.

Tuleja wzmacniająca Jevco

137

TRÓJNIK

J514



| Wymiary | Kod produktu | Opak. |
|---------|--------------|-------|
| 10 | 8514010 | 10 |
| 12 | 8514012 | 10 |
| 15 | 8514015 | 10 |
| 18 | 8514018 | 10 |
| 22 | 8514022 | 10 |
| 28 | 8514028 | 10 |
| 35 | 8614035 | 5 |
| 42 | 8614042 | 1 |
| 54 | 8614054 | 1 |

TRÓJNIK REDUKCYJNY

J515



| Wymiary (S1-S2-S3) | Kod produktu | Opak. |
|--------------------|--------------|-------|
| 22-15-22 | 85150950 | 10 |
| 28-15-28 | 85151050 | 10 |
| 28-22-28 | 85151090 | 5 |

TRÓJNIK REDUKCYJNY DWUZACISKOWY Z GWINTEM WEWNĘTRZNYM

J518



| Wymiary | Kod produktu | Opak. |
|-----------|--------------|-------|
| 12-1/2-12 | 85180343 | 10 |
| 15-1/2-15 | 85180545 | 10 |
| 18-1/2-18 | 85180747 | 10 |
| 22-1/2-22 | 85180949 | 10 |
| 22-3/4-22 | 85180969 | 10 |
| 28-1"-28 | 85181090 | 10 |

WEWNĘTRZNY REDUKTOR

J637



| Wymiary | Kod produktu | Opak. |
|---------|--------------|-------|
| 18-15 | 8637075 | 10 |
| 22-15 | 8637095 | 10 |
| 22-18 | 8637097 | 10 |

NAKRĘTKA

JCN



| Wymiary | Kod produktu | Opak. |
|---------|--------------|-------|
| 12 | 8599012 | 10 |
| 15 | 8599015 | 10 |
| 18 | 8599018 | 10 |

MOSIĘŻNY PIERŚCIEŃ STOŻKOWY

JCR



| Wymiary | Kod produktu | Opak. |
|---------|--------------|-------|
| 10 | 8599410 | 10 |
| 12 | 8599412 | 10 |
| 15 | 8599415 | 10 |
| 18 | 8599418 | 10 |
| 22 | 8599422 | 10 |
| 28 | 8599428 | 10 |
| 35 | 8599435 | 10 |

TULEJA WZMACNIAJĄCA

9216

do rur z miedzi miękkiej



| Wymiary | Kod produktu | Opak. |
|---------|--------------|-------|
| 8 | 9216008 | 50 |
| 10 | 9216010 | 50 |
| 12 | 9216012 | 50 |
| 13 | 9216013 | 50 |

ZŁĄCZKI DO ARMATURY

ZŁĄCZKA ZACISKOWA

823RMC

do rury przyłączeniowej do dystrybutora (część zamienna)



| Wymiary | Kod produktu | Opak. |
|---------|--------------|-------|
| 22-15 | 823415 | 10 |

ZŁĄCZKA ZACISKOWA

824RMC

do rury miedzianej (część zamienna)



| Wymiary | Kod produktu | Opak. |
|---------|--------------|-------|
| 15-1/2 | 824402 | 10 |

ZŁĄCZKA ZACISKOWA

825

niklowana



| Wymiary | Kod produktu | Opak. |
|---------|--------------|-------|
| M22-15 | 825415 | 10 |

ZŁĄCZKA ZACISKOWA Z PIERŚCIENIEM MOSIĘŻNYM

834

do rury miedzianej



| Wymiary | Kod produktu | Opak. |
|---------|--------------|-------|
| 12-3/8 | 587123 | 10 |
| 12-1/2 | 587124 | 10 |
| 15-1/2 | 587154 | 10 |
| 18-3/4 | 587186 | 10 |
| 22-3/4 | 587226 | 10 |

ZŁĄCZKA ZACISKOWA Z PIERŚCIENIEM MOSIĘŻNYM

835

zacisk SarFit - do grzejników dwu lub trój-panelowych



| Wymiary | Kod produktu | Opak. |
|---------|--------------|-------|
| M22-10 | 835410 | 10 |
| M22-12 | 835412 | 10 |
| M22-15 | 835415 | 10 |
| M22-18 | 835418 | 10 |

ZŁĄCZKA ZACISKOWA Z PIERŚCIENIEM ELASTYCZNYM

835E

3/4" Eurokonus - niklowana



| Wymiary | Kod produktu | Opak. |
|---------|--------------|-------|
| 18-3/4E | 835618 | 2 |

ZŁĄCZKA ZACISKOWA Z PIERŚCIENIEM ELASTYCZNYM

835EC

3 / 4 - EUROKONUS - do rury chromowanej



| Wymiary | Kod produktu | Opak. |
|---------|--------------|-------|
| 12-3/4E | 835912 | 2 |
| 14-3/4E | 835914 | 2 |
| 15-3/4E | 835915 | 2 |
| 16-3/4E | 8359161 | 2 |

ZŁĄCZKA DO ZAWORÓW DESIGN CHROME

835ECDECO

3 / 4 - EUROKONUS - chromowana



| Wymiary | Kod produktu | Opak. |
|---------|--------------|-------|
| 3/4E-14 | 8350914 | 2 |
| 3/4E-15 | 8350915 | 2 |
| 3/4E-16 | 8350916 | 2 |

ZŁĄCZKA DO ZAWORÓW DESIGN CHROME

835ECDECOS

3 / 4 - EUROKONUS - satynowana



| Wymiary | Kod produktu | Opak. |
|---------|--------------|-------|
| 3/4E-14 | 8351914 | 2 |
| 3/4E-15 | 8351915 | 2 |
| 3/4E-16 | 8351916 | 2 |

ZŁĄCZKA ZACISKOWA Z PIERŚCIENIEM ELASTYCZNYM

835S

pierścień z tworzywa sztucznego, gwintowana, niklowana, M22



| Wymiary | Kod produktu | Opak. |
|---------|--------------|-------|
| M22-12 | 835712 | 2 |
| M22-14 | 835714 | 2 |
| M22-15 | 835715 | 2 |
| M22-16 | 835716 | 2 |
| M24-18 | 835818 | 2 |

ZŁĄCZKA ZACISKOWA

836



| Wymiary | Kod produktu | Opak. |
|---------|--------------|-------|
| M22-10 | 836410 | 10 |
| M22-12 | 836412 | 10 |
| M22-14 | 836414 | 10 |
| M22-15 | 836415 | 10 |





ZŁĄCZKI ZACISKOWE TURBOSKIN

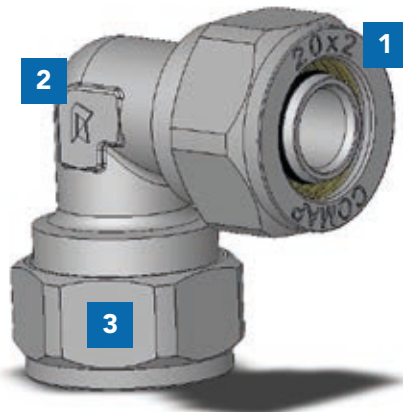

1 Uszczelka z o-ringiem wykonanym z EPDMu (TurboSKIN)

2 Symbol „A”, gwarancja jakości Comap

3 Wysokiej jakości mosiądz CW617N (TurboSKIN)

ZASTOSOWANIE

| | Zastosowanie |
|------------------------|---|
| TurboSKIN | instalacje chłodnicze: 5°C/10 bar instalacje grzewcze: 95°C/10bar instalacje sanitarne: 95°C/10 bar woda albo 50% woda/50% glikol |
| zaciskowe SUDO (Jevco) | instalacje chłodnicze: 5°C/10 bar instalacje grzewcze: 110°C/6 bar instalacje sanitarne: 95°C/16 bar woda albo 50% woda/50% glikol |

MONTAŻ

- 1 Utnij rurę pod kątem 90° przy pomocy obcinaka.
- 2 TurboSKIN: kalibruj rurę przy pomocy kalibratora Comap. Jevco: gratuj rurę przy pomocy papieru ściernego albo narzędzia do gratowania.
- 3 Zamontuj nakrętkę a potem pierścień na rurze. Wsuń złączkę w rurę aż do oporu aby zapewnić dobry zacisk.
- 4 Zakręć mocno nakrętkę bez skręcania samej rury.

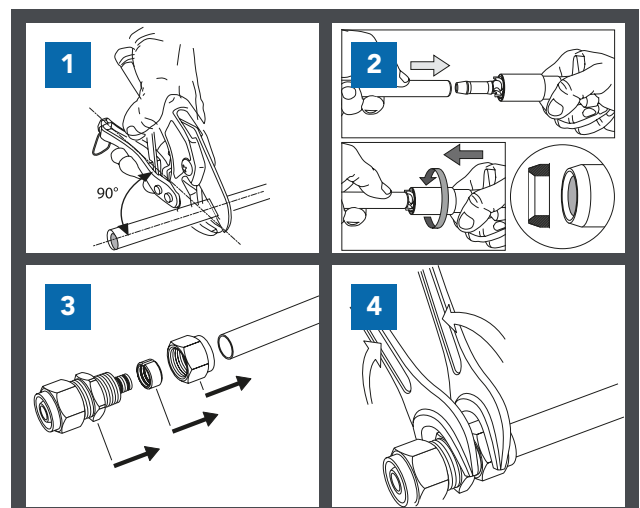

| | TurboSKIN | zaciskowe SUDO (Jevco) |
|-----------------|--|---|
| Moment obrotowy | średni zalecany moment: 30Nm dla \varnothing 14mm – \varnothing 26mm 40Nm > \varnothing 26mm | średni zalecany moment: 20Nm < 1/2" 30Nm dla 1/2" i 3/4" 40Nm > 1" |

PARAMETRY TECHNICZNE

Rury PEX i wielowarstwowe muszą spełniać następujące parametry:

| | TurboSKIN rura wielowarstwowa | | | | | |
|--------------------------|----------------------------------|----|----|----|----|----|
| średnica zewnętrzna (mm) | 14 | 16 | 18 | 20 | 26 | 32 |
| grubość (mm) | 2 | 2 | 2 | 2 | 3 | 3 |
| średnica wewnętrzna (mm) | 10 | 12 | 14 | 16 | 20 | 26 |

Złączki zaciskowe SUDO (Jevco) powinny być używane z rurami miedzianymi spełniającymi normę EN 1057, kwiecień 2006.

ZŁĄCZKI SUDO DO LUTOWANIA

Złączki SUDO do lutowania są dostępne dla rur miedzianych:

- Miedziane złączki do lutowania do rur o średnicach od 6 do 108 mm.
- Mosiężne złączki do lutowania do rur miedzianych o średnicach od 10 do 76 mm.
- Złączki z brązu do lutowania do rur miedzianych o średnicach od 10 do 108 mm.



ZASTOSOWANIE

- Złączki SUDO do lutowania mogą być używane w instalacjach wody ciepłej, zimnej i grzewczej. Można je stosować w różnych instalacjach przemysłowych. Część gamy może być przeznaczona do transportu gazu, butanu, propanu i gazu ziemnego zgodnie z lokalnymi uwarunkowaniami prawnymi.
- Złączki SUDO do lutowania powinny być stosowane wyłącznie z rurami miedzianymi zgodnymi z normami EN 1057.

| | sanitarne | gaz | ogrzewanie | chłodzenie |
|-----------------------------|-----------|-----|------------|------------|
| miedziane SUDO do lutowania | ○ | ○ | ○ | ○ |
| mosiężne SUDO do lutowania | ○ | | ○ | ○ |
| SUDO do lutowania z brązu | ○ | | ○ | ○ |

Parametry pracy złączek do lutowania SUDO z mosiądzu i brązu:

- instalacje chłodnicze: 5°C/10 barów
- instalacje grzewcze: 110°C/6 barów
- instalacje sanitarne: 95°C/16 barów
- woda albo 50% woda/50% glikol



LUTOWANE
(MIEDŹ)



GWINTOWANE
(MOSIĄDZ I BRĄZ)



PRODUKOWANE
W EUROPIE
(MIEDŹ I MOSIĄDZ)

ZALETY

- Szeroka gama produktów wysokiej jakości.
- Jakość odpowiada normie EN 1254-1.
- Symbol "A" zapewnia rozpoznawalność złączek mosiężnych.
- Obróbka termiczna większości naszych złączek mosiężnych daje im niezrównaną odporność.

CECHY

- Złączki miedziane SUDO o średnicach od 6 do 108 mm.
- Złączki mosiężne SUDO o średnicach od 10 do 76 mm.
- Złączki SUDO z brązu o średnicach od 10 do 108 mm.
- Zgodne z normą EN 1254-1.

Certyfikaty:



(tylko dla złączek miedzianych)

ŁUK 90° JEDNOKIELICHOWY

1ACU / 5001A

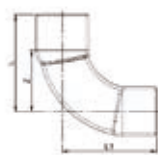

1aCu/5001A

| Wymiary | Kod produktu | L | Z | L1 | Opak. |
|---------|--------------|-------|-------|-------|-------|
| 10 | 071010 | 21 | 13,2 | 21 | 10 |
| 12 | 071012 | 23,5 | 14,9 | 23,5 | 10 |
| 15 | 071015 | 28,7 | 18,1 | 29 | 25 |
| 18 | 071018 | 34,4 | 21,8 | 35 | 10 |
| 22 | 071022 | 42 | 26,6 | 42 | 10 |
| 28 | 071028 | 52,2 | 33,8 | 52,2 | 10 |
| 35 | 071035 | 53,5 | 30,5 | 55,5 | 10 |
| 42 | 071042 | 64,5 | 37,5 | 67 | 1 |
| 54 | 071054 | 82 | 50 | 84,5 | 1 |
| 64 | 071064 | 98,5 | 66 | 110,5 | 1 |
| 76 | 071076 | 124,8 | 91,3 | 127,8 | 1 |
| 89,9 | 071089 | 144,2 | 106,7 | 147,2 | 1 |
| 108 | 071108 | 153 | 105,5 | 156 | 1 |

ŁUK 90° DWUKIELICHOWY

2ACU / 5002A

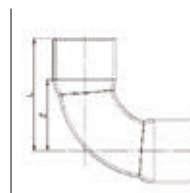

2aCu/5002A

| Wymiary | Kod produktu | L | Z | Opak. |
|---------|--------------|-------|-------|-------|
| 8 | 072008 | - | - | 10 |
| 10 | 072010 | 21 | 13,2 | 10 |
| 12 | 072012 | 23,5 | 14,9 | 10 |
| 15 | 072015 | 28,8 | 18,2 | 25 |
| 18 | 072018 | 34,4 | 21,8 | 10 |
| 22 | 072022 | 42 | 26,6 | 10 |
| 28 | 072028 | 52,2 | 33,8 | 10 |
| 35 | 072035 | 53,5 | 30,5 | 10 |
| 42 | 072042 | 64,5 | 37,5 | 1 |
| 54 | 072054 | 82 | 50 | 1 |
| 64 | 072064 | 113,5 | 81 | 1 |
| 76 | 072076 | 124,8 | 91,3 | 1 |
| 89 | 072089 | 144,2 | 106,7 | 1 |
| 108 | 072108 | 153 | 105,5 | 1 |

ŁUK 90° JEDNOKIELICHOWY

92CU / 5092

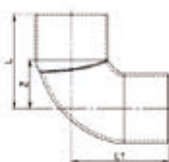

92Cu/5092

| Wymiary | Kod produktu | L | Z | L1 | Opak. |
|---------|--------------|-------|-------|------|-------|
| 10 | 092010 | 16,5 | 8,7 | 16,5 | 10 |
| 12 | 092012 | 18,8 | 10,2 | 20,8 | 10 |
| 15 | 092015 | 21,5 | 10,9 | 23 | 25 |
| 18 | 092018 | 25 | 12,4 | 27 | 10 |
| 22 | 092022 | 30,5 | 15,1 | 33 | 10 |
| 28 | 092028 | 36 | 17,6 | 40 | 10 |
| 35 | 092035 | 47,55 | 24,55 | 53,5 | 10 |
| 42 | 092042 | 57,05 | 30,05 | 64 | 1 |
| 54 | 092054 | 71,05 | 39,05 | 79 | 1 |

ŁUK 90° DWUKIELICHOWY

90CU / 5090

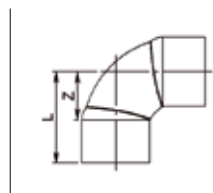

90Cu/5090

| Wymiary | Kod produktu | L | Z | Opak. |
|---------|--------------|-------|------|-------|
| 6 | 090006 | - | - | 10 |
| 8 | 090008 | 14,2 | 7,4 | 10 |
| 10 | 090010 | 16,5 | 8,7 | 10 |
| 12 | 090012 | 18,8 | 10,2 | 10 |
| 15 | 090015 | 21,5 | 10,9 | 25 |
| 18 | 090018 | 25 | 12,4 | 10 |
| 22 | 090022 | 30,5 | 15,1 | 10 |
| 28 | 090028 | 36 | 17,6 | 10 |
| 35 | 090035 | 48,5 | 25,5 | 10 |
| 42 | 090042 | 58 | 31 | 1 |
| 54 | 090054 | 72 | 40 | 1 |
| 64 | 090064 | 83,5 | 51 | 1 |
| 76 | 090076 | 91,5 | 58 | 1 |
| 108 | 090108 | 125,5 | 78 | 1 |

ŁUK 180° DWUKIELICHOWY

60CU / 5060

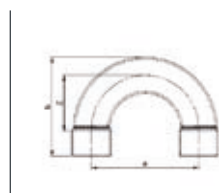

60Cu/5060

| Wymiary | Kod produktu | Z | a | b | Opak. |
|---------|--------------|------|-------|------|-------|
| 10 | 083010 | 16 | 30 | 29 | 10 |
| 12 | 083012 | 18,4 | 36 | 33 | 10 |
| 15 | 083015 | 37,5 | 45 | 39 | 10 |
| 18 | 083018 | 27,9 | 54 | 49,5 | 10 |
| 22 | 083022 | 29,2 | 56,84 | 55,6 | 10 |

ŁUK 45° JEDNOKIELICHOWY

40CU / 5040



40Cu/5040

| Wymiary | Kod produktu | L | Z | L1 | Opak. |
|---------|--------------|------|------|------|-------|
| 10 | 080010 | 13,6 | 5,8 | 15,6 | 10 |
| 12 | 080012 | 15 | 6,4 | 15 | 10 |
| 15 | 080015 | 18 | 7,4 | 18 | 25 |
| 18 | 080018 | 20,5 | 7,9 | 20,5 | 10 |
| 22 | 080022 | 25 | 9,6 | 25 | 10 |
| 28 | 080028 | 31 | 12,6 | 31 | 10 |
| 35 | 080035 | 35,5 | 12,5 | 37 | 10 |
| 42 | 080042 | 43 | 16 | 44,5 | 1 |
| 52 | 080052 | 51 | 20 | 51 | 1 |
| 54 | 080054 | 51 | 19 | 55 | 1 |
| 64 | 080064 | 60 | 27,5 | 62 | 1 |
| 76 | 080076 | 66 | 32,5 | 69 | 1 |
| 89 | 080089 | 75 | 37,5 | 78 | 1 |
| 108 | 080108 | 89 | 41,5 | 92 | 1 |

ŁUK 45° DWUKIELICHOWY

41CU / 5041



41Cu/5041

| Wymiary | Kod produktu | L | Z | Opak. |
|---------|--------------|------|------|-------|
| 10 | 081010 | 13,6 | 5,8 | 10 |
| 12 | 081012 | 15 | 6,4 | 10 |
| 15 | 081015 | 18 | 7,4 | 25 |
| 18 | 081018 | 20,5 | 7,9 | 10 |
| 22 | 081022 | 25 | 9,6 | 10 |
| 28 | 081028 | 31 | 12,6 | 10 |
| 35 | 081035 | 35,5 | 12,5 | 10 |
| 42 | 081042 | 43 | 16 | 1 |
| 54 | 081054 | 51 | 19 | 1 |
| 64 | 081064 | 60 | 27,5 | 1 |
| 76 | 081076 | 66 | 32,5 | 1 |
| 89 | 081089 | 75 | 37,5 | 1 |
| 108 | 081108 | 89 | 41,5 | 1 |

TRÓJNIK RÓWNOPRZEPLYWOWY

130CU / 5130

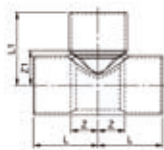

130Cu/5130

| Wymiary | Kod produktu | L | Z | L1 | Z1 | Opak. |
|---------|--------------|-------|-------|-------|------|-------|
| 6 | 130006 | 13 | 7,2 | 13,7 | 7,9 | 10 |
| 8 | 130008 | 13 | 7,2 | 12,75 | 6,95 | 10 |
| 10 | 130010 | 15 | 7,2 | 15 | 7,2 | 10 |
| 12 | 130012 | 16 | 7,4 | 15,75 | 7,15 | 10 |
| 15 | 130015 | 19 | 8,4 | 19 | 8,4 | 25 |
| 18 | 130018 | 23 | 10,4 | 23,5 | 10,9 | 10 |
| 22 | 130022 | 26,5 | 11,1 | 29,5 | 14,1 | 10 |
| 28 | 130028 | 33,5 | 15,1 | 34 | 15,6 | 10 |
| 35 | 130035 | 42,5 | 19,5 | 41 | 18 | 10 |
| 42 | 130042 | 52 | 25 | 52 | 25 | 1 |
| 54 | 130054 | 64 | 32 | 64 | 32 | 1 |
| 64 | 130064 | 73,25 | 40,75 | 73,5 | 41 | 1 |
| 76 | 130076 | 80 | 46,5 | 80 | 46,5 | 1 |
| 89 | 130089 | 92,5 | 55 | 95 | 57,5 | 1 |
| 108 | 130108 | 112 | 64,5 | 112 | 64,5 | 1 |

MUFA

270CU / 5270

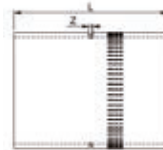

270Cu/5270

| Wymiary | Kod produktu | L | Z | Opak. |
|---------|--------------|------|-----|-------|
| 6 | 270006 | 13 | 1,4 | 10 |
| 8 | 270008 | 15 | 1,4 | 10 |
| 10 | 270010 | 16,4 | 0,8 | 10 |
| 12 | 270012 | 18 | 0,8 | 10 |
| 15 | 270015 | 22 | 0,8 | 25 |
| 18 | 270018 | 26 | 0,8 | 10 |
| 22 | 270022 | 31,5 | 0,7 | 10 |
| 28 | 270028 | 39 | 2,2 | 10 |
| 35 | 270035 | 49,5 | 3,5 | 10 |
| 42 | 270042 | 57 | 3 | 1 |
| 54 | 270054 | 66 | 2 | 1 |
| 64 | 270064 | 67 | 2 | 1 |
| 76 | 270076 | 70 | 3 | 1 |
| 89 | 270089 | 76 | 1 | 1 |
| 108 | 270108 | 107 | 12 | 1 |

TRÓJNIK REDUKCYJNY

130CUR / 5130R

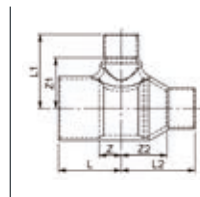

130CuR/5130R

| Wymiary (S1-S2-S3) | Kod produktu | L | Z | L1 | Z1 | L2 | Z2 | Opak. |
|--------------------|--------------|-------|-------|-------|-------|-------|-------|-------|
| 8-6-8 | 131008 | 13 | 6,2 | 13,7 | 7,9 | 13 | 6,2 | 10 |
| 10-6-10 | 131102 | - | - | - | - | - | - | 10 |
| 10-10-8 | 131121 | 15 | 7,2 | 15 | 7,2 | 16 | 9,2 | 10 |
| 10-12-10 | 131132 | 19 | 11,2 | 15,75 | 7,15 | 19 | 11,2 | 10 |
| 10-15-10 | 131052 | 23,5 | 15,7 | 19 | 8,4 | 23,5 | 15,7 | 25 |
| 12-6-12 | 131203 | - | - | - | - | - | - | 10 |
| 12-8-12 | 131213 | 16 | 7,4 | 19,5 | 12,7 | 16 | 7,4 | 10 |
| 12-10-10 | 131222 | 16 | 7,4 | 19 | 11,2 | 19 | 11,2 | 10 |
| 12-10-12 | 131223 | 16 | 7,4 | 19 | 11,2 | 16 | 7,4 | 10 |
| 12-12-10 | 131232 | 16,75 | 8,15 | 17 | 8,4 | 18,25 | 10,45 | 10 |
| 12-15-12 | 131253 | 22,5 | 13,9 | 19 | 8,4 | 22,5 | 13,9 | 25 |
| 12-18-12 | 131273 | 23 | 14,4 | 23,5 | 10,9 | 26 | 17,4 | 10 |
| 15-10-15 | 131525 | 18,75 | 8,15 | 20,5 | 12,7 | 18,75 | 8,15 | 25 |
| 15-12-12 | 131533 | 18,75 | 8,15 | 18 | 9,4 | 20 | 11,4 | 25 |
| 15-12-15 | 131535 | 18,75 | 8,15 | 18 | 9,4 | 18,75 | 8,15 | 25 |
| 15-15-12 | 131553 | 19 | 8,4 | 19 | 8,4 | 22,5 | 13,9 | 25 |
| 15-18-12 | 131573 | 27,5 | 16,9 | 23,5 | 10,9 | 26 | 17,4 | 25 |
| 15-18-15 | 131575 | 27,5 | 16,9 | 23,5 | 10,9 | 27,5 | 16,9 | 25 |
| 15-22-15 | 131595 | 32 | 21,4 | 29,5 | 14,1 | 32 | 21,4 | 25 |
| 18-12-12 | 131833 | 20,75 | 8,15 | 19,5 | 10,9 | 21 | 12,4 | 10 |
| 18-12-15 | 131835 | 20,75 | 8,15 | 19,5 | 10,9 | 21,5 | 10,9 | 25 |
| 18-12-18 | 131837 | 20,75 | 8,15 | 19,5 | 10,9 | 20,75 | 8,15 | 10 |
| 18-15-12 | 131853 | 20,5 | 7,9 | 21 | 10,4 | 24 | 15,4 | 25 |
| 18-15-15 | 131855 | 20,5 | 7,9 | 21 | 10,4 | 24,5 | 13,9 | 25 |
| 18-15-18 | 131857 | 20,5 | 7,9 | 21 | 10,4 | 20,5 | 7,9 | 25 |
| 18-18-12 | 131873 | 22,5 | 9,9 | 23,5 | 10,9 | 26 | 17,4 | 10 |
| 18-18-15 | 131875 | 22,5 | 9,9 | 23,5 | 10,9 | 27,5 | 16,9 | 25 |
| 18-22-15 | 131895 | 32,5 | 19,9 | 29,5 | 14,1 | 32 | 21,4 | 25 |
| 18-22-18 | 131897 | 32 | 19,4 | 29,5 | 14,1 | 32 | 19,4 | 10 |
| 18-28-18 | 131907 | 38,5 | 25,9 | 34 | 15,6 | 38,5 | 25,9 | 10 |
| 22-12-12 | 132233 | 23,75 | 8,35 | 25 | 16,4 | 27 | 18,4 | 10 |
| 22-12-15 | 132235 | 23,75 | 8,35 | 27,5 | 18,9 | 28,5 | 17,9 | 10 |
| 22-12-18 | 132237 | 23,75 | 8,35 | 27,5 | 18,9 | 29 | 16,4 | 10 |
| 22-12-22 | 132239 | 23,75 | 8,35 | 27,5 | 18,9 | 23,75 | 8,35 | 10 |
| 22-15-15 | 132255 | 23,75 | 8,35 | 26 | 15,4 | 28,5 | 17,9 | 25 |
| 22-15-18 | 132257 | 23,75 | 8,35 | 26 | 15,4 | 29 | 16,4 | 25 |
| 22-15-22 | 132259 | 23,75 | 8,35 | 26 | 15,4 | 23,75 | 8,35 | 25 |
| 22-18-15 | 132275 | 25,25 | 9,85 | 26 | 13,4 | 30 | 19,4 | 25 |
| 22-18-18 | 132277 | 25,25 | 9,85 | 26 | 13,4 | 30,5 | 17,9 | 10 |
| 22-22-12 | 132293 | 26,25 | 10,85 | 29,5 | 14,1 | 30,5 | 21,9 | 10 |
| 22-18-22 | 132279 | 25,25 | 9,85 | 26 | 13,4 | 25,25 | 9,85 | 10 |
| 22-22-15 | 132295 | 26,25 | 10,85 | 29,5 | 14,1 | 32 | 21,4 | 25 |
| 22-22-18 | 132297 | 26,25 | 10,85 | 29,5 | 14,1 | 32,5 | 19,9 | 10 |
| 22-28-22 | 132299 | 39 | 23,6 | 34 | 15,6 | 39 | 23,6 | 10 |
| 22-28-15 | 132300 | 40,5 | 25,1 | 34 | 15,6 | 42,25 | 31,65 | 25 |
| 22-35-22 | 132319 | 51 | 35,6 | 41 | 18 | 51 | 35,6 | 10 |
| 28-12-28 | 132840 | 31,5 | 13,1 | 36,5 | 27,9 | 31,5 | 13,1 | 10 |
| 28-15-15 | 132855 | 27,5 | 9,1 | 26,25 | 15,65 | 34,5 | 23,9 | 10 |

| Wymiary (S1-S2-S3) | Kod produktu | L | Z | L1 | Z1 | L2 | Z2 | Opak. |
|--------------------|--------------|-------|-------|-------|-------|-------|-------|-------|
| 28-15-18 | 132857 | 27,5 | 9,1 | 26,25 | 15,65 | 34 | 21,4 | 10 |
| 28-15-22 | 132859 | 27,5 | 9,1 | 26,25 | 15,65 | 33 | 17,6 | 10 |
| 28-15-28 | 132860 | 27,5 | 9,1 | 26,25 | 15,65 | 27,5 | 9,1 | 25 |
| 28-18-15 | 132875 | 31,5 | 13,1 | 35 | 22,4 | 38,5 | 27,9 | 10 |
| 28-18-18 | 132877 | 31,5 | 13,1 | 35 | 22,4 | 37,5 | 24,9 | 10 |
| 28-18-22 | 132879 | 31,5 | 13,1 | 35 | 22,4 | 36,5 | 21,1 | 10 |
| 28-18-28 | 132880 | 31,5 | 13,1 | 35 | 22,4 | 31,5 | 13,1 | 10 |
| 28-22-15 | 132895 | 31,5 | 13,1 | 30,5 | 15,1 | 38,25 | 27,65 | 10 |
| 28-22-18 | 132897 | 31,5 | 13,1 | 30,5 | 15,1 | 37,5 | 24,9 | 10 |
| 28-22-22 | 132899 | 31,5 | 13,1 | 30,5 | 15,1 | 36,5 | 21,1 | 10 |
| 28-22-28 | 132900 | 31,5 | 13,1 | 30,5 | 15,1 | 31,5 | 13,1 | 10 |
| 28-28-15 | 132905 | 33,5 | 15,1 | 34 | 15,6 | 42 | 31,4 | 25 |
| 28-28-18 | 132907 | 33,5 | 15,1 | 34 | 15,6 | 38,5 | 25,9 | 10 |
| 28-28-22 | 132909 | 33,5 | 15,1 | 34 | 15,6 | 39 | 23,6 | 10 |
| 28-35-28 | 132920 | 48,75 | 30,35 | 41 | 18 | 48,75 | 30,35 | 10 |
| 35-15-28 | 133560 | 40 | 17 | 46,75 | 36,15 | 46 | 27,6 | 10 |
| 35-15-35 | 133561 | 40 | 17 | 46,75 | 36,15 | 40 | 17 | 10 |
| 35-18-28 | 133580 | 40 | 17 | 46 | 33,4 | 46 | 27,6 | 10 |
| 35-18-35 | 133581 | 40 | 17 | 46 | 33,4 | 40 | 17 | 10 |
| 35-22-22 | 133599 | 40 | 17 | 45 | 29,6 | 48,25 | 32,85 | 10 |
| 35-22-28 | 133600 | 40 | 17 | 45 | 29,6 | 46 | 27,6 | 10 |
| 35-22-35 | 133601 | 40 | 17 | 45 | 29,6 | 40 | 17 | 10 |
| 35-28-22 | 133609 | 40 | 17 | 38 | 19,6 | 48,25 | 32,85 | 10 |
| 35-28-28 | 133610 | 40 | 17 | 38 | 19,6 | 46 | 27,6 | 10 |
| 35-35-15 | 133614 | 42,5 | 19,5 | 41 | 18 | 52,5 | 41,9 | 10 |
| 35-28-35 | 133615 | 40 | 17 | 38 | 19,6 | 40 | 17 | 10 |
| 35-35-18 | 133617 | 42,5 | 19,5 | 41 | 18 | 52 | 39,4 | 10 |
| 35-35-22 | 133619 | 42,5 | 19,5 | 41 | 18 | 51 | 35,6 | 10 |
| 35-35-28 | 133620 | 42,5 | 19,5 | 41 | 18 | 48,75 | 30,35 | 10 |
| 42-15-42 | 134263 | 43,5 | 16,5 | 44,5 | 33,9 | 43,5 | 16,5 | 1 |
| 42-18-42 | 134283 | 43,5 | 16,5 | 45,5 | 32,9 | 43,5 | 16,5 | 1 |
| 42-22-35 | 134301 | 43,5 | 16,5 | 46,5 | 31,1 | 43,5 | 20,5 | 1 |
| 42-22-42 | 134303 | 43,5 | 16,5 | 46,5 | 31,1 | 43,5 | 16,5 | 1 |
| 42-28-35 | 134311 | 43,5 | 16,5 | 43,5 | 25,1 | 43,5 | 20,5 | 1 |
| 42-28-42 | 134313 | 43,5 | 16,5 | 43,5 | 25,1 | 43,5 | 16,5 | 1 |
| 42-32-42 | 134317 | 49 | 22 | 49 | 28,6 | 49 | 22 | 1 |
| 42-35-35 | 134321 | 49 | 22 | 48,5 | 25,5 | 49 | 26 | 1 |
| 42-35-42 | 134323 | 49 | 22 | 48,5 | 25,5 | 49 | 22 | 1 |
| 42-42-28 | 134340 | 52 | 25 | 52 | 25 | 52 | 33,6 | 1 |
| 42-42-35 | 134341 | 52 | 25 | 52 | 25 | 52 | 29 | 1 |
| 54-15-54 | 135455 | 54,5 | 22,5 | 58 | 47,4 | 54,5 | 22,5 | 1 |
| 54-22-54 | 135505 | 54,5 | 22,5 | 57 | 41,6 | 54,5 | 22,5 | 1 |
| 54-28-42 | 135513 | 54,5 | 22,5 | 53 | 34,6 | 54,5 | 27,5 | 1 |
| 54-28-54 | 135515 | 54,5 | 22,5 | 57 | 38,6 | 54,5 | 22,5 | 1 |
| 54-35-42 | 135523 | - | - | - | - | - | - | 1 |
| 54-35-54 | 135525 | 54,5 | 22,5 | 53 | 30 | 54,5 | 22,5 | 1 |
| 54-42-42 | 135543 | 58,5 | 26,5 | 58 | 31 | 58,5 | 31,5 | 1 |
| 54-42-54 | 135545 | 58,5 | 26,5 | 58 | 31 | 58,5 | 26,5 | 1 |
| 54-54-42 | 135563 | 64 | 32 | 64 | 32 | 64 | 37 | 1 |
| 64-35-64 | 135616 | 72 | 39,5 | 77 | 54 | 72 | 39,5 | 1 |
| 64-42-64 | 135646 | 58 | 25,5 | 64 | 37 | 58 | 25,5 | 1 |
| 64-54-64 | 136566 | 65 | 32,5 | 68 | 36 | 65 | 32,5 | 1 |
| 67-28-67 | 136818 | 78 | 44,5 | 82 | 63,6 | 78 | 44,5 | 10 |
| 67-35-67 | 136828 | 78 | 44,5 | 82 | 59 | 78 | 44,5 | 1 |
| 67-42-67 | 136848 | 78 | 44,5 | 82 | 55 | 78 | 44,5 | 10 |
| 67-54-67 | 136868 | 69,5 | 36 | 78 | 46 | 69,5 | 36 | 1 |
| 76-28-76 | 1377161 | 80 | 46,5 | 77 | 58,6 | 80 | 46,5 | 10 |
| 76-35-76 | 137726 | 80 | 46,5 | 80 | 57 | 80 | 46,5 | 1 |

| Wymiary (S1-S2-S3) | Kod produktu | L | Z | L1 | Z1 | L2 | Z2 | Opak. |
|--------------------|--------------|-----|------|------|------|-----|------|-------|
| 76-42-76 | 137746 | 80 | 46,5 | 81 | 54 | 80 | 46,5 | 1 |
| 76-54-76 | 137766 | 80 | 46,5 | 81 | 49 | 80 | 46,5 | 1 |
| 89-54-89 | 139057 | 77 | 38,5 | 87,5 | 55,5 | 77 | 38,5 | 1 |
| 89-64-89 | 139077 | 87 | 49,5 | 93 | 60,5 | 87 | 49,5 | 1 |
| 108-35-108 | 139908 | 112 | 64,5 | 115 | 92 | 112 | 64,5 | 1 |
| 108-42-108 | 139928 | 113 | 65,5 | 111 | 84 | 113 | 65,5 | 1 |
| 108-54-108 | 139948 | 113 | 65,5 | 106 | 74 | 113 | 65,5 | 1 |
| 108-76-108 | 139978 | 113 | 65,5 | 105 | 71,5 | 113 | 65,5 | 1 |

ZŁĄCZKA REDUKCYJNA

240CU / 5240

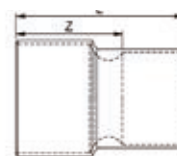

240Cu/5240

| Wymiary | Kod produktu | L | Z | Opak. |
|---------|--------------|------|------|-------|
| 10-6 | 240106 | - | - | 10 |
| 10-8 | 240108 | 18,5 | 3,9 | 10 |
| 12-8 | 240128 | 22,5 | 7,1 | 10 |
| 12-10 | 240130 | 20,5 | 4,1 | 10 |
| 15-10 | 240160 | 23 | 4,6 | 25 |
| 15-12 | 240162 | 23,1 | 3,9 | 25 |
| 18-10 | 240190 | 26 | 5,6 | 10 |
| 18-12 | 240192 | 27 | 5,8 | 10 |
| 18-15 | 240195 | 27,7 | 4,5 | 25 |
| 22-12 | 240232 | 36 | 12 | 10 |
| 22-15 | 240235 | 33,1 | 7,1 | 25 |
| 22-18 | 240238 | 33 | 5 | 10 |
| 28-15 | 240295 | 44 | 15 | 25 |
| 28-18 | 240296 | 36 | 7 | 10 |
| 28-18 | 240298 | 38,1 | 7,1 | 10 |
| 28-22 | 240302 | 41 | 7,2 | 10 |
| 35-18 | 240368 | 54 | 18,4 | 10 |
| 35-22 | 240372 | 48 | 9,6 | 10 |
| 35-28 | 240378 | 54 | 12,6 | 10 |
| 36-28 | 240388 | 55 | 12,6 | 10 |
| 42-22 | 240442 | 60,5 | 18,1 | 1 |
| 42-28 | 240448 | 60,5 | 15,1 | 1 |
| 42-32 | 240452 | 61 | 13,6 | 1 |
| 42-35 | 240455 | 66 | 16 | 1 |
| 52-32 | 240552 | 69 | 17 | 1 |
| 54-22 | 240562 | - | - | 1 |
| 54-28 | 240568 | - | - | 1 |
| 54-35 | 240575 | 79 | 24 | 1 |
| 54-42 | 240582 | 74 | 15 | 1 |
| 64-35 | 240689 | 79 | 23,5 | 1 |
| 64-42 | 240692 | 78 | 18,5 | 1 |
| 64-54 | 240694 | 78 | 23,5 | 1 |
| 76-35 | 240795 | 85 | 28,5 | 1 |
| 76-42 | 240802 | 86 | 25,5 | 1 |
| 76-54 | 240814 | 84 | 18,5 | 1 |
| 76-64 | 240824 | 80 | 14 | 1 |
| 89-76 | 240966 | 87 | 16 | 1 |
| 108-89 | 240989 | 110 | 25 | 1 |

NYPEL REDUKCYJNY

243CU / 5243

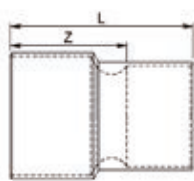

| Wymiary M-F | Kod produktu | L | Z | Opak. |
|-------------|--------------|------|------|-------|
| 6-8 | 242086 | 14 | 8,2 | 10 |
| 6-10 | 242106 | - | - | 10 |
| 8-10 | 242108 | 16 | 9,2 | 10 |
| 8-12 | 242128 | 18,5 | 11,7 | 10 |
| 10-12 | 242130 | 18,5 | 10,7 | 10 |
| 10-15 | 242160 | 21,5 | 13,7 | 25 |
| 12-15 | 242162 | 22,1 | 13,5 | 25 |
| 10-16 | 242170 | 21 | 13,2 | 10 |
| 10-18 | 242190 | 23 | 15,2 | 10 |
| 12-18 | 242192 | 25,1 | 16,5 | 10 |
| 15-18 | 242195 | 27,7 | 17,1 | 25 |
| 10-22 | 242230 | 28,5 | 20,7 | 10 |
| 12-22 | 242232 | 28,5 | 19,9 | 10 |
| 15-22 | 242235 | 33,1 | 22,5 | 25 |
| 18-22 | 242238 | 33,1 | 20,5 | 10 |
| 12-28 | 242292 | 41 | 32,4 | 10 |
| 15-28 | 242295 | 37,1 | 26,5 | 25 |
| 18-28 | 242298 | 37,1 | 24,5 | 10 |
| 22-28 | 242302 | 40,1 | 24,7 | 10 |
| 15-35 | 242365 | 51 | 40,4 | 10 |
| 18-35 | 242368 | 51 | 38,4 | 10 |
| 22-35 | 242372 | 46,1 | 30,7 | 10 |
| 28-35 | 242378 | 50,8 | 32,4 | 10 |
| 15-42 | 242435 | 68 | 57,4 | 1 |
| 18-42 | 242438 | 69 | 56,4 | 1 |
| 22-42 | 242442 | 60,5 | 45,1 | 1 |
| 28-42 | 242448 | 58 | 39,6 | 1 |
| 35-42 | 242455 | 58 | 35 | 1 |
| 22-54 | 242564 | 70,5 | 55,1 | 1 |
| 28-54 | 242568 | 69 | 50,6 | 1 |
| 35-54 | 242575 | 70,5 | 47,5 | 1 |
| 42-54 | 242582 | 70,5 | 43,5 | 1 |
| 35-64 | 242685 | 75 | 52 | 1 |
| 42-64 | 242686 | 76 | 49 | 1 |
| 54-64 | 242694 | 74 | 42 | 1 |
| 35-76 | 242795 | 91 | 68 | 1 |
| 42-76 | 242802 | 89 | 62 | 1 |
| 54-76 | 242814 | 88 | 56 | 1 |
| 64-76 | 242824 | 83 | 50,5 | 1 |
| 54-89 | 242944 | 100 | 68 | 1 |
| 64-89 | 242954 | 95 | 62,5 | 1 |
| 76-89 | 242966 | 93 | 59,5 | 1 |
| 76-108 | 242976 | 115 | 81,5 | 1 |
| 42-108 | 242982 | 117 | 90 | 1 |
| 54-108 | 242984 | 94 | 67 | 10 |
| 67-108 | 242987 | 118 | 84,5 | 1 |
| 89-108 | 242989 | 108 | 70,5 | 1 |

MUFA WSUWANA

271CU / 5271



271Cu/5271

| Wymiary | Kod produktu | L | Opak. |
|---------|--------------|------|-------|
| 15 | 271015 | 21,2 | 25 |
| 22 | 271022 | 30,8 | 10 |
| 28 | 271028 | 36,8 | 10 |

KOREK (KAPA)

300CU-C / 5301C

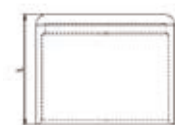

300Cu-C/5301C

| Wymiary | Kod produktu | L | Opak. |
|---------|--------------|------|-------|
| 8 | 301008 | 9 | 10 |
| 10 | 301010 | 10 | 10 |
| 12 | 301012 | 10,5 | 10 |
| 15 | 301015 | 14 | 25 |
| 18 | 301018 | 15 | 10 |
| 22 | 301022 | 18,5 | 10 |
| 28 | 301028 | 22,5 | 10 |
| 35 | 301035 | 27 | 10 |
| 42 | 301042 | 30 | 1 |
| 54 | 301054 | 35,5 | 1 |
| 64 | 301064 | 38 | 1 |
| 76 | 301076 | 40,5 | 1 |
| 89 | 301089 | 46,5 | 1 |
| 108 | 301108 | 56 | 1 |

OBEJŚCIE DWUKIELICHOWE

85CU / 5085



85Cu/5385

| Wymiary | Kod produktu | Z | a | c | Opak. |
|---------|--------------|------|------|----|-------|
| 12 | 085012 | 40,9 | 49,5 | 20 | 10 |
| 15 | 085015 | 46,4 | 57 | 20 | 10 |
| 18 | 085018 | 50,9 | 63,5 | 20 | 10 |
| 22 | 085022 | 58,1 | 73,5 | 20 | 10 |

OBEJŚCIE JEDNOKIELICHOWE

86CU / 5086



86Cu/5386

| Wymiary | Kod produktu | a | Za | b | Zb | c | Opak. |
|---------|--------------|-------|-------|----|------|----|-------|
| 12 | 086012 | 82,5 | 73,9 | 40 | 31,4 | 20 | 10 |
| 15 | 086015 | 93 | 82,4 | 40 | 29,4 | 20 | 10 |
| 18 | 086018 | 102,5 | 89,9 | 45 | 32,4 | 20 | 10 |
| 22 | 086022 | 117,5 | 102,1 | 50 | 34,6 | 20 | 10 |

AKCESORIA

KOMPENSATOR DYLATACYJNY MIEDZIANY

1090



| Wymiary | Kod produktu | Opak. |
|---------|--------------|-------|
| 12 | 397112 | 1 |
| 15 | 397115 | 1 |
| 18 | 397118 | 1 |
| 22 | 397122 | 1 |
| 28 | 397128 | 1 |
| 35 | 397135 | 1 |

NYPEL REDUKCYJNY LUT GWINT ZEWNĘTRZNY

L243GCU

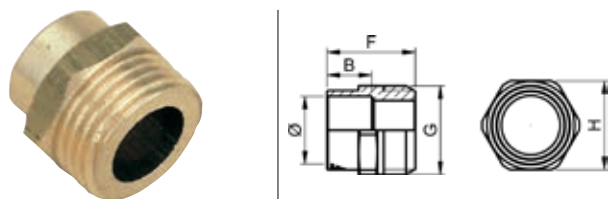

| Wymiary | Kod produktu | F | H | B | Opak. |
|----------|--------------|------|----|----|-------|
| 10-1/4 | E112031001 | 16 | 13 | 8 | 10 |
| 10-3/8 | E112033001 | 17,5 | 17 | 8 | 10 |
| 10-1/2 | E112035001 | 19 | 21 | 8 | 10 |
| 12-1/4 | E112032001 | 17 | 15 | 9 | 10 |
| 12-3/8 | E111004001 | 18,5 | 17 | 9 | 10 |
| 12-1/2 | E112036001 | 19,5 | 21 | 9 | 10 |
| 12-3/4 | E112040001 | 22,5 | 26 | 9 | 10 |
| 15-1/2 | E112037001 | 19,5 | 21 | 11 | 10 |
| 18-1/2 | E112038001 | 23 | 21 | 13 | 10 |
| 18-3/4 | E112042001 | 25 | 26 | 13 | 10 |
| 22-1/2 | E112039001 | 27 | 26 | 15 | 10 |
| 22-3/4 | E111019001 | 27 | 26 | 15 | 10 |
| 22-1" | E111021001 | 28 | 33 | 15 | 5 |
| 28-3/4 | E112044001 | 30,5 | 32 | 18 | 10 |
| 28-1" | E111022001 | 31,5 | 33 | 18 | 5 |
| 28-1 1/4 | E112046001 | 34 | 42 | 18 | 5 |
| 35-1 1/4 | E112048001 | 39 | 42 | 23 | 5 |
| 42-1 1/4 | E112051001 | 43 | 48 | 27 | 5 |
| 42-1 1/2 | E112054001 | 43 | 48 | 27 | 1 |
| 42-2" | E112055001 | 44 | 60 | 27 | 1 |
| 54-2" | E112057001 | 51 | 60 | 32 | 1 |
| 64-2" | E112059001 | 52 | 76 | 32 | 1 |
| 64-2 1/2 | E112061001 | - | - | - | 1 |
| 76-2 1/2 | E112063001 | - | - | - | 1 |

MUFA REDUKCYJNA LUT GWINT WEWNĘTRZNY

L270GCU

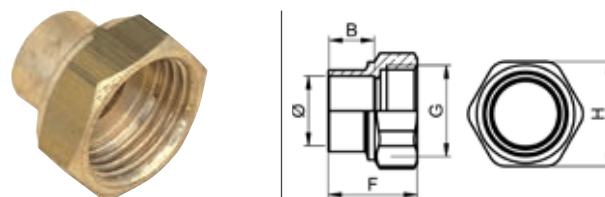

| Wymiary | Kod produktu | F | H | B | Opak. |
|----------|--------------|------|----|------|-------|
| 10-1/4 | E112064001 | 15,5 | 16 | 7,8 | 10 |
| 10-3/8 | E112066001 | 16,5 | 19 | 7,8 | 10 |
| 12-1/4 | E112065001 | 16,5 | 16 | 8,6 | 10 |
| 12-3/8 | E112067001 | 17,5 | 19 | 8,6 | 10 |
| 12-1/2 | E112070001 | 18,5 | 24 | 8,6 | 10 |
| 15-1/2 | E112071001 | 20,5 | 24 | 10,6 | 10 |
| 15-3/4 | E112075001 | 21,5 | 30 | 10,6 | 10 |
| 18-1/2 | E112072001 | 22,5 | 24 | 12,6 | 10 |
| 18-3/4 | E112077001 | 23,5 | 30 | 12,6 | 10 |
| 22-1/2 | E112073001 | 25,5 | 26 | 15,4 | 10 |
| 22-3/4 | E112079001 | 26 | 30 | 15,4 | 10 |
| 22-1" | E112081001 | 28,2 | 38 | 15,4 | 5 |
| 28-3/4 | E112080001 | 29,5 | 32 | 18,4 | 10 |
| 28-1" | E112082001 | 31 | 38 | 18,4 | 5 |
| 28-1 1/4 | E112084001 | 33 | 45 | 18,4 | 5 |
| 35-1 1/4 | E112086001 | 37,5 | 45 | 23 | 5 |
| 42-1 1/2 | E112089001 | 42,5 | 52 | 27 | 1 |
| 54-2" | E112091001 | 48,5 | 64 | 32 | 1 |

ŚRUBUNEK PROSTY DO WLUTOWANIA

340CU

uszczelnienie stożkowe



| Wymiary | Kod produktu | Opak. |
|---------|--------------|-------|
| 10 | E112104001 | 10 |
| 12 | E112105001 | 10 |
| 15 | E112107001 | 10 |
| 18 | E112108001 | 10 |
| 22 | E112109001 | 10 |
| 28 | E112110001 | 10 |

KOREK (KAPA)

300CU

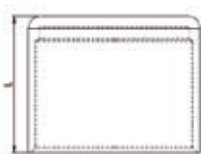

| Wymiary | Kod produktu | Opak. |
|---------|--------------|-------|
| 10 | E112092001 | 10 |
| 12 | E112093001 | 10 |
| 18 | E112096001 | 10 |
| 22 | E112097001 | 10 |
| 28 | E112098001 | 5 |
| 35 | E112100001 | 5 |
| 42 | E112102001 | 5 |
| 54 | E112103001 | 1 |

KOLANO 90° LUT GWINT WEWNĘTRZNY WYDŁUŻONE

L90GLCU



| Wymiary | Kod produktu | Opak. |
|---------|--------------|-------|
| 12-1/2 | 10819 | 10 |

ŚRUBUNEK PROSTY LUT GWINT ZEWNĘTRZNY

L341GCU

uszczelnienie stożkowe

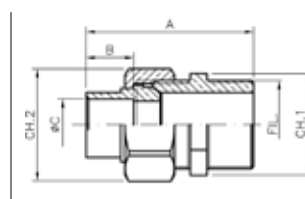

| Wymiary | Kod produktu | F | G2 | H1 | C | C1 | Opak. |
|----------|--------------|------|----------|----|----|------|-------|
| 10-1/4 | E112133001 | 10 | 3/8 | 17 | 7 | 7,8 | 10 |
| 10-3/8 | E112134001 | 10 | 3/8 | 17 | 8 | 7,8 | 10 |
| 12-3/8 | E112135001 | 11 | 1/2 | 21 | 8 | 8,8 | 10 |
| 12-1/2 | E112137001 | 11 | 1/2 | 21 | 9 | 8,8 | 10 |
| 15-1/2 | E112138001 | 12,5 | 5/8 | 23 | 9 | 10,3 | 10 |
| 18-1/2 | E112139001 | 12 | 3/4 | 26 | 9 | 9,8 | 10 |
| 18-3/4 | E112142001 | 12 | 3/4 | 26 | 10 | 9,8 | 10 |
| 22-3/4 | E111129001 | 13,5 | 7/8 | 30 | 10 | 11 | 10 |
| 22-1" | E111131001 | 13,5 | 7/8 | 33 | 12 | 11 | 5 |
| 28-3/4 | E112144001 | 15,5 | Ø 38x150 | 38 | 10 | 12,5 | 10 |
| 28-1" | E111132001 | 15,5 | Ø 38x150 | 38 | 12 | 12,5 | 5 |
| 28-1 1/4 | E111134001 | 15,5 | Ø 38x150 | 42 | 14 | 12,5 | 5 |
| 28-1 1/2 | E112149001 | 15,5 | Ø 38x150 | 48 | 15 | 12,5 | 1 |
| 35-1 1/4 | E112146001 | 18 | 1 1/2 | 48 | 14 | 15 | 5 |
| 36-1 1/4 | E112147001 | 18 | 1 1/2 | 48 | 14 | 15 | 5 |
| 42-1 1/4 | E112148001 | 19 | 1 3/4 | 54 | 14 | 16 | 5 |
| 42-1 1/2 | E112152001 | 19 | 1 3/4 | 53 | 15 | 16 | 1 |
| 54-2" | E112154001 | 21 | 2 1/4 | 76 | 20 | 17 | 1 |
| 64-2" | E112156001 | 22 | 2 1/2 | 76 | 20 | 18 | 1 |

ŁĄCZNIK GWINT WEWNĘTRZNY

L359GCU

uszczelka płaska – złączka miedziana – nakrętka mosiężna



| Wymiary | Kod produktu | Opak. |
|----------|--------------|-------|
| 10-3/8 | E112158001 | 10 |
| 10-1/2 | E112160001 | 10 |
| 12-3/8 | E112159001 | 10 |
| 12-1/2 | E112161001 | 10 |
| 12-3/4 | E112164001 | 10 |
| 15-1/2 | E112163001 | 25 |
| 18-3/4 | E112167001 | 10 |
| 18-1" | E112169001 | 5 |
| 22-1" | E112170001 | 5 |
| 28-1 1/4 | E112171001 | 5 |
| 36-1 1/2 | E112173001 | 5 |

KOLANO 90°

C2AGCU

uszczelka płaska – łuk miedziany – nakrętka mosiężna



| Wymiary | Kod produktu | Opak. |
|---------|--------------|-------|
| 10-3/8 | E111204001 | 25 |
| 12-3/8 | E111205001 | 25 |
| 12-1/2 | E111207001 | 25 |
| 15-1/2 | E111209001 | 25 |
| 18-1/2 | E111211001 | 25 |
| 18-3/4 | E111214001 | 25 |
| 22-3/4 | E111215001 | 25 |
| 22-1" | E111216001 | 10 |
| 28-1" | E111217001 | 10 |

DWUZŁĄCZKA PROSTA

C359GLCU

uszczelka płaska – złączka miedziana – nakrętka mosiężna



| Wymiary | Kod produktu | Opak. |
|----------|--------------|-------|
| 10-3/8 | E112174001 | 25 |
| 10-1/2 | E112177001 | 25 |
| 12-3/8 | E112175001 | 25 |
| 12-1/2 | E112178001 | 25 |
| 15-1/2 | E112179001 | 10 |
| 18-1/2 | E112181001 | 25 |
| 18-3/4 | E131012001 | 25 |
| 22-3/4 | E131013001 | 25 |
| 22-1" | E112184001 | 10 |
| 28-3/4 | E112183001 | 25 |
| 28-1" | E112185001 | 10 |
| 28-1 1/4 | E112186001 | 10 |
| 42-1 1/2 | E112188001 | 10 |

ŚRUBUNEK PROSTY LUT GWINT WEWNĘTRZNY

L340GCU

uszczelnienie stożkowe

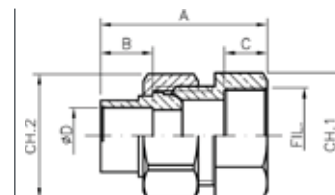

| Wymiary | Kod produktu | F | G2 | H1 | C | C1 | Opak. |
|----------|--------------|------|---------------------------|----|-----|------|-------|
| 10-3/8 | E112112001 | 10 | 3/8 | 19 | 8 | 7,8 | 10 |
| 12-3/8 | E112113001 | 11 | 1/2 | 21 | 7,5 | 8,8 | 10 |
| 12-1/2 | E112115001 | 11 | 1/2 | 24 | 8,5 | 8,8 | 10 |
| 18-1/2 | E112118001 | 12 | 3/4 | 26 | 8,5 | 9,8 | 10 |
| 18-3/4 | E112121001 | 12 | 3/4 | 29 | 10 | 9,8 | 10 |
| 22-3/4 | E111102001 | 13,5 | 7/8 | 30 | 9,5 | 11 | 10 |
| 22-1" | E111104001 | 13,5 | 7/8 | 36 | 11 | 11 | 5 |
| 28-3/4 | E112122001 | 15,5 | $\emptyset 38 \times 150$ | 38 | 9,5 | 12,5 | 10 |
| 28-1" | E111105001 | 15,5 | $\emptyset 38 \times 150$ | 38 | 11 | 12,5 | 5 |
| 28-1 1/4 | E112124001 | 15,5 | $\emptyset 38 \times 150$ | 45 | 13 | 12,5 | 5 |
| 35-1 1/4 | E112126001 | 18 | 1 1/2 | 48 | 13 | 15 | 5 |
| 36-1 1/4 | E112127001 | 18 | 1 1/2 | 48 | 13 | 15 | 5 |
| 42-1 1/2 | E112130001 | 19 | 1 3/4 | 53 | 14 | 16 | 1 |
| 54-2" | E112132001 | 21 | 2 1/4 | 64 | 15 | 17 | 1 |

KOLANO 90° LUT GWINT ZEWNĘTRZNY

L92GCU



| Wymiary | Kod produktu | Opak. |
|---------|--------------|-------|
| 12-3/8 | 1372 | 10 |
| 12-1/2 | 1374 | 10 |
| 18-1/2 | 1378 | 10 |
| 18-3/4 | 1380 | 10 |
| 22-3/4 | 1382 | 10 |
| 22-1" | 1383 | 5 |
| 28-1" | 1384 | 10 |

KOLANO 90° LUT GWINT WEWNĘTRZNY

L90GCU

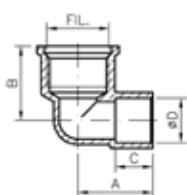

| Wymiary | Kod produktu | A | B | C | Opak. |
|---------|--------------|------|------|----|-------|
| 12-3/8 | 1386 | 20 | 20 | 10 | 10 |
| 12-1/2 | 1388 | 21,5 | 22 | 10 | 10 |
| 18-1/2 | 1392 | 25 | 25 | 14 | 10 |
| 18-3/4 | 1394 | 28,5 | 28,5 | 14 | 10 |
| 22-3/4 | 1396 | 30,5 | 30,5 | 17 | 10 |
| 22-1" | 1397 | 34 | 33 | 17 | 5 |
| 28-1" | 1398 | 38 | 35 | 20 | 10 |

ŚRUBUNEK KĄTOWY LUT GWINT WEWNĘTRZNY

L96GCU

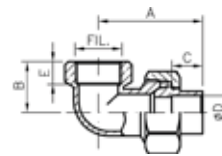

| Wymiary | Kod produktu | A | B | C | E | Opak. |
|---------|--------------|------|------|------|------|-------|
| 12-3/8 | 1442 | 37,5 | 18 | 11 | 8 | 10 |
| 18-3/4 | 1450 | 46 | 23 | 14 | 10,5 | 10 |
| 22-3/4 | 1452 | 52 | 25,3 | 17,5 | 10,5 | 10 |
| 22-1" | 1453 | 55 | 41 | 17,5 | 12 | 10 |
| 28-1" | 1454 | 67,3 | 41 | 23,7 | 12 | 5 |

KOLANO 90° GWINT WEWNĘTRZNY

L90GRCU

duży kąt



| Wymiary | Kod produktu | Opak. |
|---------|--------------|-------|
| 12-3/8 | 10809 | 10 |
| 12-1/2 | 10811 | 10 |
| 18-1/2 | 10815 | 10 |

ŚRUBUNEK KĄTOWY LUT GWINT ZEWNĘTRZNY

L98GCU

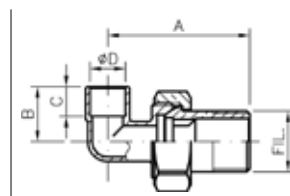

| Wymiary | Kod produktu | A | B | C | Opak. |
|---------|--------------|----|----|----|-------|
| 12-3/8 | 1415 | 48 | 20 | 10 | 10 |
| 18-3/4 | 1423 | 55 | 26 | 14 | 10 |
| 22-3/4 | 1425 | 58 | 31 | 17 | 10 |
| 22-1" | 1426 | 65 | 31 | 17 | 5 |
| 28 1" | 1427 | 70 | 37 | 20 | 5 |

KOLANO JEDNOKIELICHOWE GWINT ZEWNĘTRZNY

L92GLCU

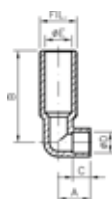

| Wymiary | Kod produktu | A | B | C | Opak. |
|---------|--------------|----|----|----|-------|
| 12-3/8 | 10832 | 18 | 50 | 10 | 10 |

PROSTY KUREK ODPŁYWU DWUKIELICHOWY

130PCU

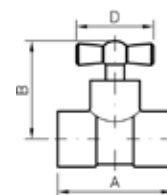

| Wymiary | Kod produktu | A | B | D | Opak. |
|---------|--------------|----|----|----|-------|
| 12 | 1477 | 35 | 27 | 33 | 10 |
| 18 | 1481 | 43 | 30 | 33 | 10 |
| 22 | 1483 | 49 | 32 | 33 | 10 |

KĄTOWY KUREK ODPŁYWU DWUKIELICHOWY

90PCU

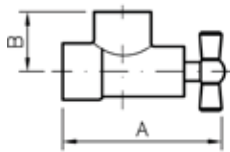

| Wymiary | Kod produktu | A | B | Opak. |
|---------|--------------|------|------|-------|
| 12 | 1485 | 34,5 | 17 | 10 |
| 18 | 1489 | 54 | 23,5 | 10 |

TRÓJNIK LUT GWINT WEWNĘTRZNY

L130GCU

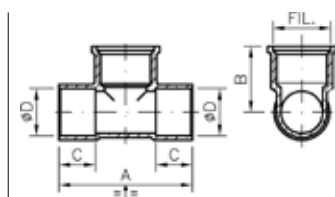

| Wymiary | Kod produktu | A | B | C | Opak. |
|---------|--------------|----|------|----|-------|
| 12-3/8 | 1493 | 39 | 23 | 10 | 10 |
| 12-1/2 | 1495 | 43 | 22 | 10 | 10 |
| 18-1/2 | 1499 | 51 | 25 | 14 | 10 |
| 22-1/2 | 1500 | 53 | 29,5 | 17 | 10 |
| 22-3/4 | 1501 | 59 | 30,5 | 17 | 10 |

KOLANO 90° DWUKIELICHOWE

8090



| Wymiary | Kod produktu | A | B | ØC | Opak. |
|---------|--------------|----|------|----|-------|
| 1/8 | 1623 | - | - | - | 10 |
| 1/4 | 1624 | 19 | 19 | 9 | 10 |
| 3/8 | 1625 | 20 | 11 | 14 | 10 |
| 1/2 | E212004001 | 22 | 11 | 18 | 10 |
| 3/4 | E212005001 | 27 | 13,5 | 23 | 10 |
| 1*1/4 | 1629 | 45 | 20 | 36 | 5 |
| 1*1/2 | 1630 | 48 | 21,5 | 40 | 5 |
| 1" | E212006001 | 35 | 15,5 | 30 | 5 |
| 2" | 1631 | 58 | 23,5 | 51 | 1 |

KOLANO 90° GWINT WEWNĘTRZNY

8090N

niklowane

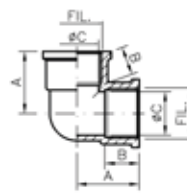

| Wymiary | Kod produktu | A | B | ØC | Opak. |
|---------|--------------|----|----|----|-------|
| 3/8 | 3979 | 20 | 11 | 14 | 10 |
| 1/2 | 3980 | 22 | 11 | 18 | 10 |

KOLANO 90° GWINT ZEWNĘTRZNY

8091

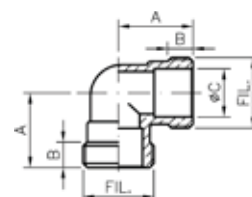

| Wymiary | Kod produktu | A | B | Opak. |
|---------|--------------|----|-----|-------|
| 3/8 | 1616 | 20 | 7 | 10 |
| 1/2 | 1617 | 22 | 7,5 | 10 |
| 3/4 | E212012001 | 26 | 9 | 10 |
| 1" | 1619 | 32 | 10 | 10 |
| 1*1/4 | 1620 | 45 | 18 | 5 |
| 1*1/2 | 1621 | 48 | 20 | 5 |
| 2" | 1622 | 58 | 22 | 1 |

KOLANO 90° GWINT ZEWNĘTRZNY WEWNĘTRZNY

8092

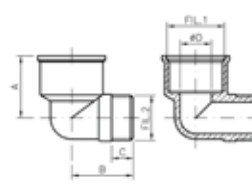

| Wymiary | Kod produktu | A | B | C | E | Opak. |
|---------|--------------|------|------|------|------|-------|
| 1/8 | 316 | - | - | - | - | 10 |
| 1/4 | 1632 | 19 | 21 | 9 | 8,5 | 10 |
| 3/8 | 1633 | 23 | 9,85 | 9,85 | 13 | 10 |
| 1/2 | E212020001 | 26,5 | 27 | 12,5 | 15 | 10 |
| 3/4 | E212021001 | 30,5 | 29 | 12,4 | 17 | 10 |
| 1*1/4 | 1637 | 45 | 45 | 18 | 20 | 5 |
| 1*1/2 | 1638 | 48 | 27 | 20 | 21,5 | 5 |
| 1" | E212022001 | 36 | 35,5 | 13,5 | 19 | 10 |
| 2" | 317 | 58 | 58 | 22 | 23,5 | 1 |

KOLANO 90° REDUKCYJNE
GWINT ZEWNĘTRZNY WEWNĘTRZNY

8092R

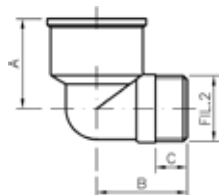

| Wymiary | Kod produktu | A | B | C | E | Opak. |
|---------|--------------|------|------|----|---|-------|
| 1/2-3/4 | 1639 | 28,5 | 28,5 | 10 | 0 | 10 |

KOLANO 90° KRÓTKIE
GWINT ZEWNĘTRZNY WEWNĘTRZNY

8092L



| Wymiary | Kod produktu | Opak. |
|---------|--------------|-------|
| 3/8 | E121001001 | 10 |
| 1/2 | E121002001 | 10 |
| 3/4 | E121003001 | 10 |
| 1" | 10493 | 5 |

KOLANO 90° GWINT WEWNĘTRZNY ZEWNĘTRZNY

8092C

niklowane

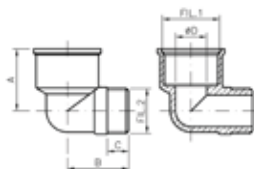

| Wymiary | Kod produktu | A | B | C | E | Opak. |
|---------|--------------|------|------|------|----|-------|
| 3/8 | 3988 | 23 | 9,85 | 9,85 | 13 | 10 |
| 1/2 | 3989 | 26,5 | 27 | 12,5 | 15 | 10 |

KOLANO 90°

8012

z jednakowymi nakrętkami



| Wymiary | Kod produktu | Opak. |
|---------|--------------|-------|
| 1/2 | 3810 | 10 |
| 3/4 | 3811 | 10 |

TRÓJNIK RÓWNOPRZEPLYWOWY

8130

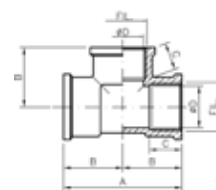

| Wymiary | Kod produktu | A | B | C | Opak. |
|---------|--------------|-----|----|------|-------|
| 1/4 | 1606 | - | - | - | 10 |
| 3/8 | 1607 | 40 | 20 | 11 | 10 |
| 1/2 | E212033001 | 44 | 22 | 11 | 10 |
| 3/4 | E212034001 | 54 | 27 | 13,5 | 10 |
| 1" | E212035001 | 70 | 35 | 15,5 | 5 |
| 1 1/4 | 1611 | 90 | 45 | 20 | 5 |
| 1 1/2 | 1612 | 96 | 48 | 21,5 | 5 |
| 2" | 1613 | 114 | 57 | 23,5 | 1 |

TRÓJNIK RÓWNOPRZEPLYWOWY GWINT WEWNĘTRZNY

8130C

niklowany

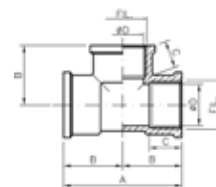

| Wymiary | Kod produktu | A | B | C | Opak. |
|---------|--------------|----|----|------|-------|
| 1/2 | 8130104 | 44 | 22 | 11 | 10 |
| 3/4 | 3963 | 54 | 27 | 13,5 | 10 |

TRÓJNIK RÓWNOPRZEPŁYWOWY GWINT ZEWNĘTRZNY

8131

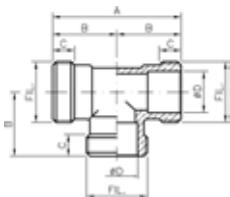

| Wymiary | Kod produktu | A | B | C | Opak. |
|---------|--------------|-----|----|-----|-------|
| 3/8 | 1598 | 40 | 20 | 7 | 10 |
| 1/2 | E212040001 | 44 | 22 | 7,5 | 10 |
| 3/4 | 1600 | 52 | 26 | 9 | 10 |
| 1" | 1601 | 64 | 32 | 10 | 5 |
| 1 1/4 | 1602 | 90 | 45 | 18 | 5 |
| 1 1/2 | 1603 | 96 | 48 | 20 | 5 |
| 2" | 1604 | 116 | 58 | 22 | 1 |

ŚRUBUNEK PROSTY GWINT ZEWNĘTRZNY

8093

uszczelnienie stożkowe

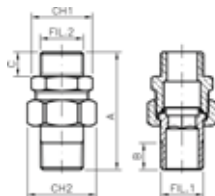

| Wymiary | Kod produktu | A | B | C | Opak. |
|---------|--------------|----|------|-----|-------|
| 1/4 | 3900 | 51 | 10,1 | 8,5 | 10 |
| 3/8 | 1457 | 58 | 13,5 | 12 | 10 |
| 1/2 | 1458 | 60 | 12 | 13 | 10 |
| 3/4 | 1459 | 68 | 14 | 14 | 10 |
| 1" | 1460 | 79 | 15 | 16 | 5 |

ŚRUBUNEK PROSTY GWINT ZEWNĘTRZNY WEWNĘTRZNY

8094

chromowany — uszczelnienie stożkowe

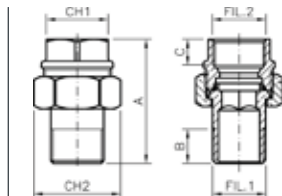

| Wymiary | Kod produktu | A | B | C | Opak. |
|---------|--------------|----|------|----|-------|
| 3/8 | 1461 | 43 | 10,1 | 7 | 10 |
| 1/2 | 1462 | 48 | 13,2 | 11 | 10 |
| 3/4 | 1463 | 51 | 12 | 11 | 10 |
| 1" | 1464 | 59 | 14 | 12 | 5 |
| 1 1/4 | 3048 | 70 | 15 | 19 | 5 |
| 1 1/2 | 3049 | - | - | - | 5 |
| 2" | 3050 | - | - | - | 1 |

ŚRUBUNEK PROSTY GWINT ZEWNĘTRZNY WEWNĘTRZNY

8094C

niklowany — uszczelnienie stożkowe

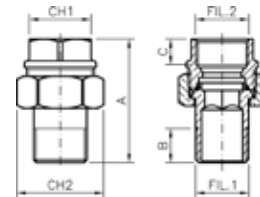

| Wymiary | Kod produktu | A | B | C | Opak. |
|---------|--------------|----|----|----|-------|
| 3/4 | 3942 | 51 | 12 | 11 | 10 |
| 1" | 3943 | 59 | 14 | 12 | 5 |
| 1 1/4 | 3944 | 70 | 15 | 19 | 5 |

KOLANO 90° GWINT ZEWNĘTRZNY WEWNĘTRZNY

8095

uszczelnienie stożkowe

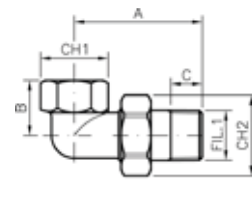

| Wymiary | Kod produktu | A | B | C | Opak. |
|---------|--------------|----|----|------|-------|
| 1/2 | 1466 | 54 | 23 | 13,2 | 10 |
| 3/4 | 1467 | 59 | 25 | 12 | 10 |
| 1" | 1468 | 70 | 35 | 14 | 5 |

REDUKCJA GWINT ZEWNĘTRZNY WEWNĘTRZNY

8199

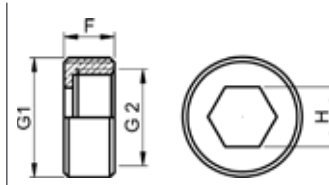

| Wymiary | Kod produktu | F | H | Opak. |
|---------|--------------|----|-----|-------|
| 3/8-1/4 | 722 | 9 | - | 10 |
| 1/2-3/8 | 724 | 10 | H10 | 10 |
| 3/4-3/8 | 726 | 11 | - | 10 |
| 3/4-1/2 | 727 | 11 | H13 | 10 |
| 1 3/4 | 731 | 13 | H17 | 10 |

REDUKCJA GWINT ZEWNĘTRZNY WEWNĘTRZNY

8199C

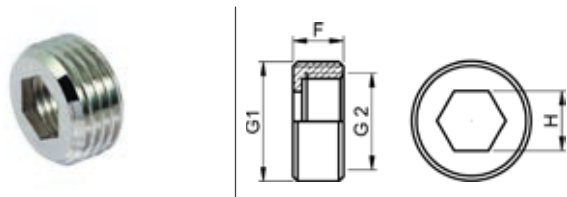

| Wymiary | Kod produktu | F | H | Opak. |
|---------|--------------|----|-----|-------|
| 1/2-3/8 | 741 | 10 | H10 | 10 |
| 3/4-1/2 | 744 | 11 | H13 | 10 |

REDUKCJA GWINT WEWNĘTRZNY

8240

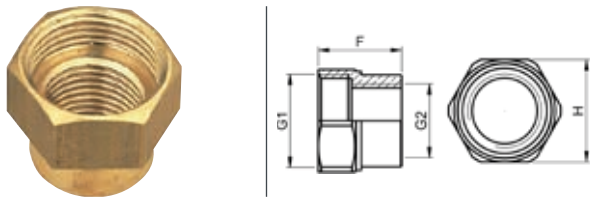

| Wymiary | Kod produktu | F | H | Opak. |
|-------------|--------------|------|----|-------|
| 3/8-1/4 | E122002001 | 16 | 19 | 10 |
| 1/2-1/4 | E122003001 | 17,3 | 24 | 10 |
| 1/2-3/8 | E122004001 | 17,3 | 24 | 10 |
| 3/4-3/8 | E122005001 | 20,5 | 29 | 10 |
| 3/4-1/2 | E122006001 | 20,8 | 29 | 10 |
| 1*1/4-3/4 | 673 | 26 | 44 | 5 |
| 1*1/4-1" | 674 | 29 | 45 | 5 |
| 1*1/2-1*1/4 | 675 | 32 | 52 | 5 |
| 1"-1/2 | E122007001 | 23 | 36 | 5 |
| 1"-3/4 | E122008001 | 24 | 36 | 5 |
| 2"-1*1/2 | 3084 | 35 | 64 | 1 |

REDUKCJA GWINT WEWNĘTRZNY

8240C

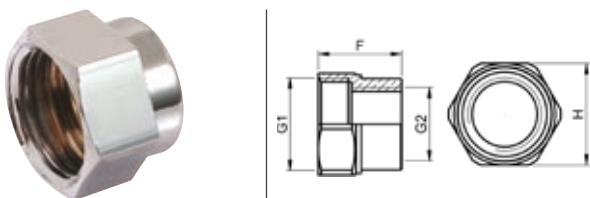

| Wymiary | Kod produktu | F | H | Opak. |
|---------|--------------|------|----|-------|
| 1/2-3/8 | E123022001 | 17,3 | 24 | 10 |
| 3/4-1/2 | E123023001 | 20,8 | 29 | 10 |

REDUKCJA GWINT ZEWNĘTRZNY WEWNĘTRZNY

8241

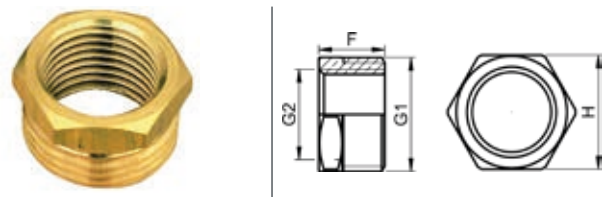

| Wymiary | Kod produktu | F | H | Opak. |
|-------------|--------------|------|----|-------|
| 3/8-1/8 | 755 | 11,5 | 17 | 10 |
| 3/8-1/4 | 756 | 11,5 | 17 | 10 |
| 1/4-1/8 | 754 | 10 | 15 | 10 |
| 1/2-1/8 | 757 | 13 | 21 | 10 |
| 1/2-3/8 | E122010001 | 13 | 21 | 10 |
| 1/2-1/4 | E122009001 | 13 | 21 | 10 |
| 3/4-1/4 | 760 | 15,5 | 26 | 10 |
| 3/4-3/8 | E122011001 | 15,5 | 26 | 10 |
| 3/4-1/2 | E122012001 | 15,5 | 26 | 10 |
| 1*3/8 | 763 | 17,5 | 33 | 10 |
| 1*-3/4 | E122014001 | 17,5 | 33 | 10 |
| 1*-1/2 | E122013001 | 17,5 | 33 | 10 |
| 1*1/4-1/2 | 766 | 20 | 42 | 5 |
| 1*1/4-3/4 | 767 | 20 | 42 | 5 |
| 1*1/4-1" | 768 | 20 | 42 | 5 |
| 1*1/2-3/4 | 771 | 21 | 48 | 5 |
| 1*1/2-1*1/4 | 773 | 21 | 48 | 5 |
| 1*1/2-1" | 772 | 21 | 48 | 5 |
| 2*-1*1/4 | 778 | 233 | 60 | 1 |
| 2*-1*1/2 | 779 | 23 | 60 | 1 |
| 2*1/2-2" | 3080 | 32 | 80 | 1 |
| 2*-1" | 777 | 23 | 60 | 1 |

REDUKCJA GWINT ZEWNĘTRZNY WEWNĘTRZNY

8241C

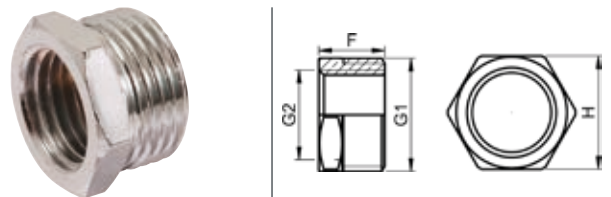

| Wymiary | Kod produktu | F | H | Opak. |
|---------|--------------|----|----|-------|
| 1/2-3/8 | E123025001 | 13 | 22 | 10 |
| 3/4-1/2 | E123024001 | 26 | 10 | 10 |

REDUKCJA GWINT ZEWNĘTRZNY WEWNĘTRZNY

8243

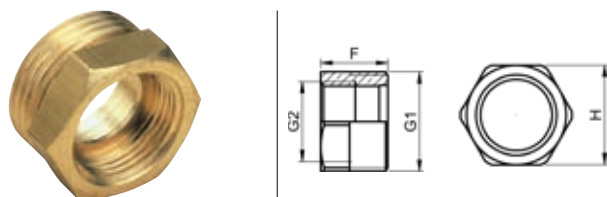

| Wymiary | Kod produktu | F | H | Opak. |
|-------------|--------------|------|----|-------|
| 3/8-1/8 | 547 | 13 | 17 | 10 |
| 3/8-1/4 | E122015001 | 14 | 17 | 10 |
| 3/4-3/8 | 553 | 17 | 26 | 10 |
| 3/4-1/2 | E211058001 | 17,5 | 26 | 10 |
| 1/4-1/8 | 546 | 12 | 13 | 10 |
| 1/2-1/4 | E122016001 | 15 | 21 | 10 |
| 1/2-3/8 | E122017001 | 15,5 | 21 | 10 |
| 1*3/8 | 564 | 21 | 33 | 10 |
| 1*-1/2 | E122018001 | 20 | 33 | 10 |
| 1*-3/4 | E211061001 | 20 | 33 | 10 |
| 1*1/4-1" | 570 | 24 | 42 | 5 |
| 1*1/2-1" | 298 | 26 | 48 | 5 |
| 1*1/4-1/2 | 568 | 24 | 42 | 5 |
| 1*1/4-3/4 | 569 | 24 | 42 | 5 |
| 1*1/2-3/4 | 571 | 26 | 48 | 5 |
| 1*1/2-1*1/4 | 572 | 26 | 48 | 5 |
| 2*-1*1/4 | 573 | 28 | 60 | 1 |
| 2*-1*1/2 | 574 | 28 | 60 | 1 |
| 2*1/2-2" | 576 | 36 | 76 | 1 |

REDUKCJA GWINT ZEWNĘTRZNY WEWNĘTRZNY

8243C

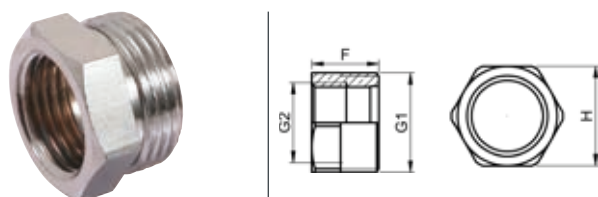

| Wymiary | Kod produktu | Opak. |
|---------|--------------|-------|
| 3/4-1/2 | E123018001 | 10 |

REDUKCJA GWINT ZEWNĘTRZNY WEWNĘTRZNY

8246

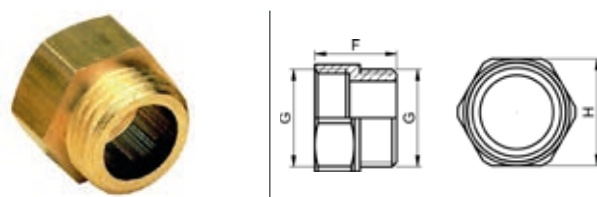

| Wymiary | Kod produktu | F | H | Opak. |
|---------|--------------|------|----|-------|
| 1/8 | 448 | 15 | 13 | 10 |
| 1/4 | E122020001 | 16 | 15 | 10 |
| 3/8 | E122021001 | 18 | 19 | 10 |
| 1/2 | E211074001 | 20,5 | 24 | 10 |
| 3/4 | E211075001 | 22,5 | 29 | 10 |
| 1*1/4 | 459 | 30 | 45 | 5 |
| 1*1/2 | 460 | 32,5 | 52 | 5 |
| 1" | E122022001 | 26,5 | 36 | 5 |
| 2" | 461 | 35 | 64 | 1 |

REDUKCJA GWINT ZEWNĘTRZNY WEWNĘTRZNY

8246C

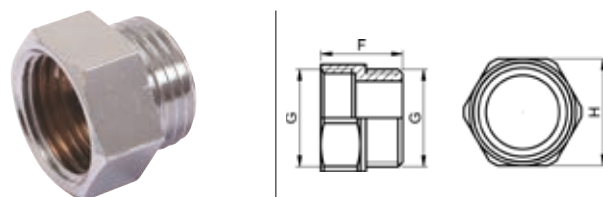

| Wymiary | Kod produktu | F | H | Opak. |
|---------|--------------|------|----|-------|
| 3/8 | E123013001 | 18 | 19 | 10 |
| 1/2 | E123014001 | 20,5 | 24 | 10 |
| 3/4 | E123015001 | 22,5 | 29 | 10 |

REDUKCJA GWINT ZEWNĘTRZNY WEWNĘTRZNY

8245

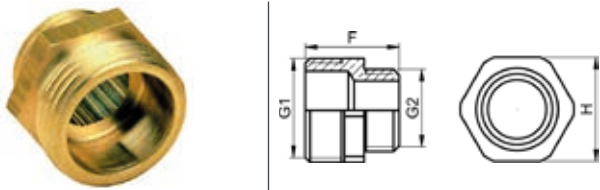

| Wymiary | Kod produktu | F | H | Opak. |
|-------------|--------------|------|----|-------|
| 3/8-1/8 | 375 | 18 | 17 | 10 |
| 3/8-1/4 | 376 | 18 | 17 | 10 |
| 3/4-3/8 | 385 | 23 | 26 | 10 |
| 3/4-1/2 | E211087001 | 24 | 26 | 10 |
| 1/4-1/8 | 374 | 17 | 13 | 10 |
| 1/2-1/4 | 378 | 20 | 21 | 10 |
| 1/2-3/8 | E211084001 | 21 | 21 | 10 |
| 5/8-1/2 | E122019001 | 23,5 | 23 | 10 |
| 1*1/2 | 394 | 26 | 33 | 10 |
| 1*-3/4 | E211089001 | 27 | 33 | 10 |
| 1*1/4-1" | E211091001 | 32 | 42 | 5 |
| 1*1/4-3/4 | 398 | 29,5 | 42 | 5 |
| 1*1/2-1" | 402 | 34 | 48 | 5 |
| 1*1/2-1*1/4 | 403 | 36 | 48 | 5 |
| 2*-1*1/4 | 405 | 39 | 60 | 1 |
| 2*-1*1/2 | 406 | 39 | 60 | 1 |

REDUKCJA GWINT ZEWNĘTRZNY

8245C

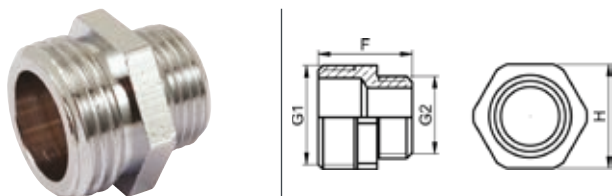

| Wymiary | Kod produktu | F | H | Opak. |
|---------|--------------|----|----|-------|
| 1/2-3/8 | E123011001 | 21 | 21 | 10 |
| 3/4-1/2 | E123012001 | 24 | 26 | 10 |

REDUKCJA GWINT ZEWNĘTRZNY WEWNĘTRZNY

8246RC

chromowana

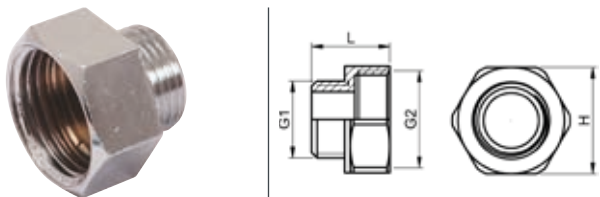

| Wymiary | Kod produktu | F | H | Opak. |
|---------|--------------|------|----|-------|
| 3/8-1/2 | E123016001 | 19,5 | 24 | 10 |
| 1/2-3/4 | E123017001 | 21,5 | 29 | 10 |

ZŁĄCZKA WYDŁUŻONA GWINT WEWNĘTRZNY ZEWNĘTRZNY DŁUGOŚĆ GWINTU 40MM

8246L



| Wymiary | Kod produktu | Opak. |
|---------|--------------|-------|
| 3/8 | E122055001 | 10 |
| 1/2 | E122056001 | 10 |
| 3/4 | E122057001 | 10 |

REDUKCJA GWINT ZEWNĘTRZNY WEWNĘTRZNY

8246R

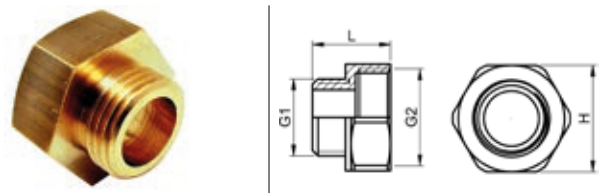

| Wymiary | Kod produktu | F | H | Opak. |
|-------------|--------------|------|----|-------|
| 1/8-1/4 | E122058001 | 17,7 | 15 | 10 |
| 1/8-3/8 | E122059001 | 17 | 19 | 10 |
| 1/8-1/2 | E122060001 | 18,5 | 24 | 10 |
| 1/4-3/8 | E122061001 | 20 | 19 | 10 |
| 1/4-1/2 | E122062001 | 18,5 | 24 | 10 |
| 1/4-3/4 | E122063001 | 22,5 | 29 | 10 |
| 3/8-1/2 | E211105001 | 19,5 | 24 | 10 |
| 3/8-3/4 | E122064001 | 21 | 29 | 10 |
| 1/2-5/8 | E122065001 | 22 | 25 | 10 |
| 1/2-3/4 | E211108001 | 21,5 | 29 | 10 |
| 3/4-1" | E211111001 | 24,5 | 36 | 10 |
| 3/4-1*1/4 | 505 | 27 | 44 | 5 |
| 1*1/4-1*1/2 | 511 | 33 | 52 | 5 |
| 1*1/4-2" | 512 | 34 | 65 | 10 |
| 1/2-1" | E122066001 | 24 | 36 | 10 |
| 1/2-1*1/4 | 499 | 26 | 44 | 10 |
| 1*1/2-2" | 513 | 35 | 64 | 1 |
| 1*-1*1/4 | E211113001 | 28 | 45 | 5 |
| 1*-1*1/2 | 509 | 31 | 52 | 5 |
| 1*-2" | 510 | 31 | 65 | 5 |
| 2*-2*1/2 | 624 | - | - | 1 |

MUFA GWINT WEWNĘTRZNY

8270

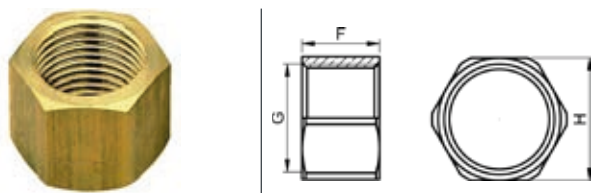

| Wymiary | Kod produktu | F | H | Opak. |
|---------|--------------|----|----|-------|
| 1/8 | E122023001 | 15 | 14 | 10 |
| 1/4 | E122024001 | 16 | 16 | 10 |
| 3/8 | E122025001 | 15 | 21 | 10 |
| 1/2 | E122026001 | 17 | 25 | 10 |
| 3/4 | E122027001 | 19 | 30 | 10 |
| 1" | E122028001 | 27 | 38 | 5 |
| 1 1/4 | 621 | 31 | 45 | 5 |
| 1 1/2 | 622 | 33 | 54 | 5 |
| 2" | 623 | 36 | 68 | 1 |

MUFA GWINT WEWNĘTRZNY

8270C

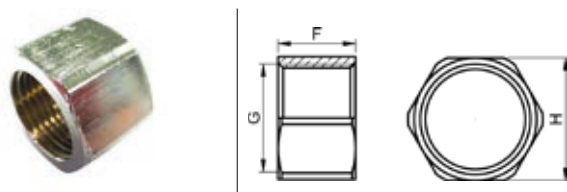

| Wymiary | Kod produktu | F | H | Opak. |
|---------|--------------|----|----|-------|
| 3/8 | E123019001 | 15 | 21 | 10 |
| 3/4 | E123021001 | 19 | 30 | 10 |
| 1/2 | E123020001 | - | - | 10 |

MUFA GWINT WEWNĘTRZNY

8271

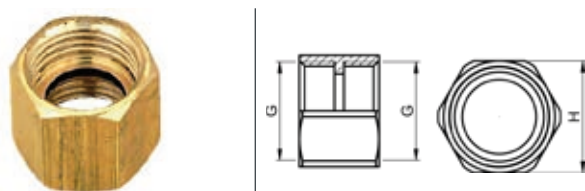

| Wymiary | Kod produktu | F | H | Opak. |
|---------|--------------|------|----|-------|
| 1/4 | E122029001 | 17 | 16 | 10 |
| 3/8 | E122030001 | 17 | 21 | 10 |
| 1/2 | E211131001 | 19 | 24 | 10 |
| 3/4 | E122031001 | 21,5 | 30 | 10 |
| 1" | E122032001 | 25 | 38 | 5 |
| 1 1/4 | 649 | 31 | 45 | 5 |
| 1 1/2 | 650 | 33 | 54 | 5 |
| 2" | 651 | 36 | 64 | 1 |

NYPEL GWINT ZEWNĘTRZNY

8280

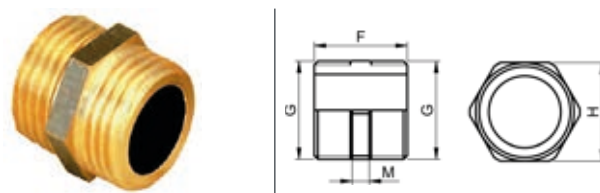

| Wymiary | Kod produktu | H | F | G | M | Opak. |
|---------|--------------|----|------|---------|-----|-------|
| 1/8 | 333 | 11 | 17 | G 1/8 | 3 | 10 |
| 1/4 | 334 | 13 | 17 | G 1/4 | 3 | 10 |
| 3/8 | E211139001 | 17 | 19,5 | G 3/8 | 3,5 | 10 |
| 1/2 | E211140001 | 21 | 22 | G 1/2 | 4 | 10 |
| 3/4 | E211141001 | 26 | 24,5 | G 3/4 | 4,5 | 10 |
| 1" | E211142001 | 33 | 29 | G 1" | 5 | 5 |
| 1 1/4 | E211143001 | 42 | 34 | G 1 1/4 | 6 | 5 |
| 1 1/2 | E211144001 | 50 | 36 | G 1 1/2 | 6 | 5 |
| 2" | 349 | 60 | 38 | G 2" | 6 | 1 |
| 2 1/2 | 351 | - | - | - | - | 1 |

NYPEL GWINT ZEWNĘTRZNY

8280C

chromowana

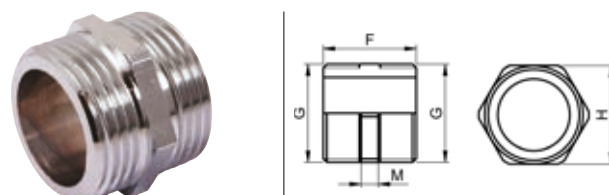

| Wymiary | Kod produktu | L | H | D | M | N mini | Opak. |
|---------|--------------|----|------|-------|-----|--------|-------|
| 3/8 | E123007001 | 17 | 19,5 | G 3/8 | 3,5 | 10 | 10 |
| 1/2 | E123008001 | 21 | 22 | G 1/2 | 4 | 10 | 10 |
| 3/4 | E123009001 | 26 | 24,5 | G 3/4 | 4,5 | 10 | 10 |
| 1" | E123010001 | 33 | 29 | G 1" | 5 | 5 | 5 |

NYPEL WYDŁUŻONY GWINT ZEWNĘTRZNY 40MM

8280L

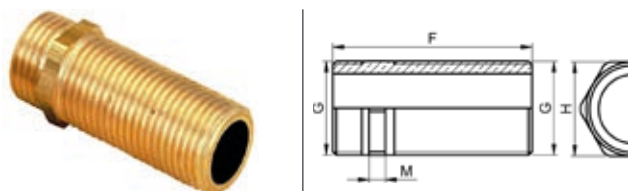

| Wymiary | Kod produktu | H | F | G | M | Opak. |
|---------|--------------|----|----|-------|---|-------|
| 3/8 | E122033001 | 17 | 51 | G 3/8 | 3 | 10 |
| 1/2 | E122034001 | 21 | 53 | G 1/2 | 4 | 10 |
| 3/4 | E122035001 | 26 | 55 | G 3/4 | 5 | 10 |
| 1" | E122036001 | 33 | 57 | G 1" | 5 | 5 |

NYPEL GWINT ZEWNĘTRZNY

8281

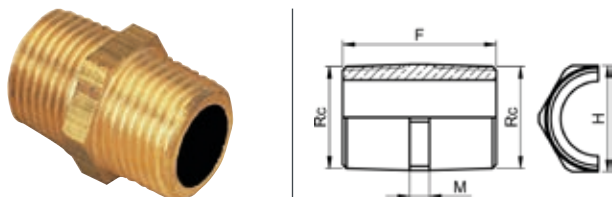

| Wymiary | Kod produktu | F | H | M | R - Conical | Opak. |
|---------|--------------|----|----|---|-------------|-------|
| 3/8 | E122037001 | 29 | 17 | 5 | Rc 3/8 | 10 |
| 1/2 | 295 | 35 | 23 | 5 | Rc 1/2 | 10 |
| 3/4 | 296 | 39 | 27 | 5 | Rc 3/4 | 10 |

KOREK GWINT WEWNĘTRZNY

8300

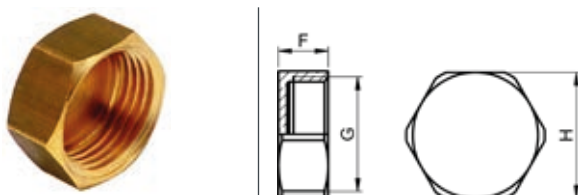

| Wymiary | Kod produktu | F | H | Opak. |
|---------|--------------|------|----|-------|
| 1/8 | E122046001 | 8 | 12 | 10 |
| 1/4 | E122047001 | 8 | 15 | 10 |
| 3/8 | E211167001 | 9,5 | 19 | 10 |
| 1/2 | E211168001 | 10,5 | 24 | 10 |
| 5/8 | E122048001 | 12 | 25 | 10 |
| 3/4 | E211170001 | 11,5 | 29 | 10 |
| 1" | E122049001 | 13 | 36 | 5 |
| 1 1/4" | E122050001 | 15 | 44 | 5 |
| 1 1/2" | E122051001 | 16 | 52 | 5 |
| 2" | E122052001 | 17,5 | 65 | 1 |

KOREK GWINT WEWNĘTRZNY

8300C

chromowana

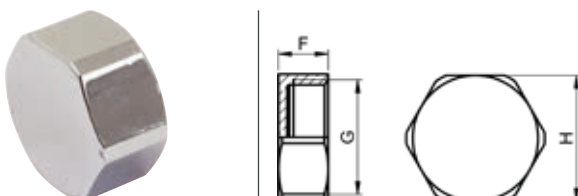

| Wymiary | Kod produktu | F | H | Opak. |
|---------|--------------|------|----|-------|
| 3/8 | E123026001 | 9,5 | 19 | 10 |
| 1/2 | E123027001 | 10,5 | 24 | 10 |
| 3/4 | E123028001 | 11,5 | 29 | 10 |

KOREK GWINT ZEWNĘTRZNY

8292

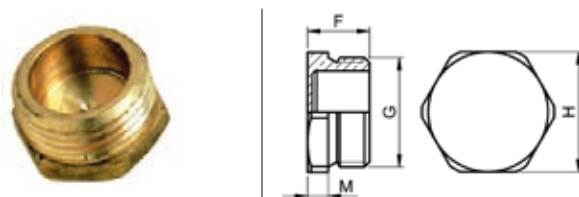

| Wymiary | Kod produktu | F | H | M | Opak. |
|---------|--------------|-----|----|-----|-------|
| 1/8 | E122038001 | 2,5 | 13 | 2,5 | 10 |
| 3/8 | E122040001 | 3 | 19 | 3 | 10 |
| 5/8 | E122041001 | 4,5 | 26 | 4,5 | 10 |
| 3/4 | E211160001 | 5 | 29 | 5 | 10 |
| 1/4 | E122039001 | 2,5 | 15 | 2,5 | 10 |
| 1/2 | E211158001 | 4,5 | 23 | 4,5 | 10 |
| 1" | E122042001 | 6 | 36 | 6 | 5 |
| 1 1/4" | E122043001 | 7 | 44 | 7 | 5 |
| 1 1/2" | E122044001 | 8 | 52 | 8 | 5 |
| 2" | E122045001 | 10 | 65 | 10 | 1 |

KOREK GWINT ZEWNĘTRZNY

8292C

chromowana

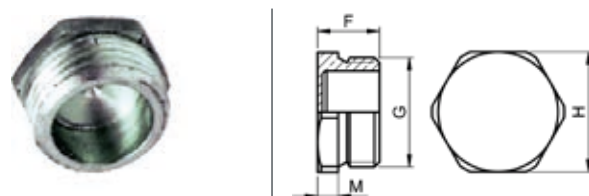

| Wymiary | Kod produktu | F | H | M | Opak. |
|---------|--------------|-----|----|-----|-------|
| 3/8 | E123029001 | 3 | 19 | 3 | 10 |
| 3/4 | E123031001 | 5 | 29 | 5 | 10 |
| 1/2 | E123030001 | 4,5 | 23 | 4,5 | 10 |

REDUKCJA GWINT WEWNĘTRZNY

8342R

z nakrętką obrotową



| Wymiary | Kod produktu | Opak. |
|---------|--------------|-------|
| 3/8-1/2 | 2571 | 10 |
| 1/2-3/4 | 692 | 10 |

ŁĄCZNIK GWINT WEWNĘTRZNY

8342

z dwiema jednakowymi nakrętkami obrotowymi



| Wymiary | Kod produktu | Opak. |
|---------|--------------|-------|
| 3/8 | 637 | 10 |
| 1/2 | 638 | 10 |
| 3/4 | 639 | 10 |
| 1" | 256 | 5 |

NAKRĘTKA SZEŚCIOKĄTNA

8374GC

rozszerzana - chromowana



| Wymiary | Kod produktu | Opak. |
|---------|--------------|-------|
| 10-3/8 | E123001001 | 10 |
| 10-1/2 | E123003001 | 10 |
| 12-3/8 | E123002001 | 10 |
| 12-1/2 | E123004001 | 10 |

NAKRĘTKA SZEŚCIOKĄTNA

8374G



| Wymiary | Kod produktu | Opak. |
|----------|--------------|-------|
| 8-3/8 | E122067001 | 10 |
| 10-3/8 | E122068001 | 10 |
| 10-1/2 | E122070001 | 10 |
| 12-3/8 | E122069001 | 10 |
| 12-3/4 | E122073001 | 10 |
| 12-1/2 | E122071001 | 10 |
| 18-3/4 | E122076001 | 10 |
| 20-3/4 | E122077001 | 10 |
| 22-3/4 | E122081001 | 10 |
| 22-1" | E122078001 | 10 |
| 32-1*1/4 | E122080001 | 5 |
| 28-1*1/4 | E122079001 | 5 |

RURA GWINTOWANA

8439

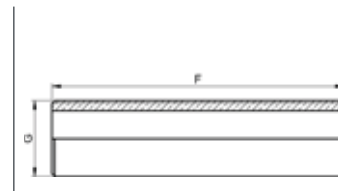

| Wymiary | Kod produktu | F - G | Opak. |
|-------------|--------------|-------------|-------|
| 1m-3/8 | 2165 | 1000-G 3/8 | 1 |
| 1m-1/2 | 2166 | 1000-G 1/2 | 1 |
| 1m-3/4 | 2167 | 1000-G 3/4 | 1 |
| 50mm-3/8 | 2204 | 50-G 3/8 | 10 |
| 50mm-1/2 | 2171 | 50-G 1/2 | 10 |
| 50mm-3/4 | 2205 | 50-G 3/4 | 10 |
| 100mm-3/8 | 2173 | 100-G 3/8 | 10 |
| 100mm-1/2 | 2174 | 100-G 1/2 | 10 |
| 100mm-3/4 | 2175 | 100-G 3/4 | 10 |
| 100mm-1" | 2176 | 100-G 1" | 10 |
| 100mm-1*1/4 | 2177 | 100-G 1*1/4 | 5 |
| 100mm-1*1/2 | 2178 | 100-G 1*1/2 | 5 |
| 1m-1" | 2168 | 1000-G 1" | 1 |

ZŁĄCZKA PRZELOTOWA

8471

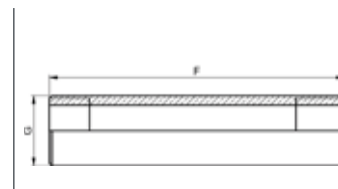

| Wymiary | Kod produktu | L | F - G | N mini | Opak. |
|-------------|--------------|----|-----------|--------|-------|
| 105-3/4-3/4 | 3228 | 15 | 105-G 3/4 | 2 | 5 |
| 110-3/4-3/4 | 3226 | 15 | 110-G 3/4 | 2 | 5 |
| 130-3/4-3/4 | 3227 | 15 | 130-G 3/4 | 2 | 5 |
| 170-3/4-3/4 | 3324 | 15 | 170-G 3/4 | 2 | 5 |

DWUZŁĄCZKA Z NAKRĘTKĄ

8359

bez uszczelki płaskiej

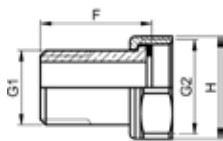

| Wymiary | Kod produktu | L | H | Opak. |
|-------------|--------------|------|----|-------|
| 3/8-1/2 | 1060 | 14,5 | 24 | 10 |
| 1/2-3/4 | 1061 | 15 | 29 | 10 |
| 3/4-1" | 1062 | 18,5 | 36 | 5 |
| 1-1 1/4 | 1063 | 21 | 45 | 5 |
| 1 1/4-1 1/2 | 1064 | 23 | 52 | 5 |
| 1 1/2-2" | 1065 | 26 | 64 | 1 |

DWUZŁĄCZKA Z NAKRĘTKĄ

8359CTP

z uszczelką płaską

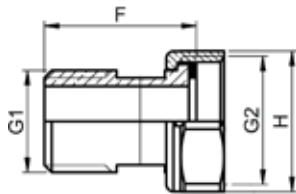

| Wymiary | Kod produktu | F | H | Opak. |
|-------------|--------------|------|----|-------|
| 1/2-1/2 | 1083 | 32,5 | 24 | 10 |
| 1/2-3/4 | 1940 | 31,5 | 29 | 10 |
| 3/4-3/4 | 1084 | 38,5 | 32 | 10 |
| 3/4-1" | 1941 | 37,5 | 36 | 5 |
| 1 1/2-2" | 1088 | 42,5 | 38 | 1 |
| 1 1/4-1 1/2 | 1087 | 41,5 | 45 | 5 |
| 1-1 1/4 | 1086 | 46,5 | 52 | 5 |
| 1-1" | 1085 | 53,5 | 64 | 10 |
| 2-2 1/2 | 1090 | - | - | 1 |

DWUZŁĄCZKA Z NAKRĘTKĄ

8359C

z uszczelką płaską

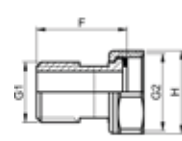

| Wymiary | Kod produktu | F | H | Opak. |
|-------------|--------------|------|----|-------|
| 3/8-1/2 | 1930 | 29,5 | 24 | 10 |
| 1/2-1/2 | 1080 | 32,5 | 24 | 10 |
| 1/2-3/4 | 1931 | 31,5 | 29 | 10 |
| 3/4-3/4 | 1081 | 38,5 | 32 | 10 |
| 3/4-1" | 1932 | 37,5 | 36 | 10 |
| 1-1" | 1082 | 42,5 | 38 | 10 |
| 1 1/4-1 1/2 | 1934 | 46,5 | 52 | 5 |
| 1 1/2-2" | 1935 | 53,5 | 64 | 1 |
| 1-1 1/4 | 1933 | 41,5 | 45 | 5 |
| 2-2 1/4 | 3417 | - | - | 1 |
| 2-2 1/2 | 1937 | - | - | 1 |

PRZEDŁUŻENIE

8446EB

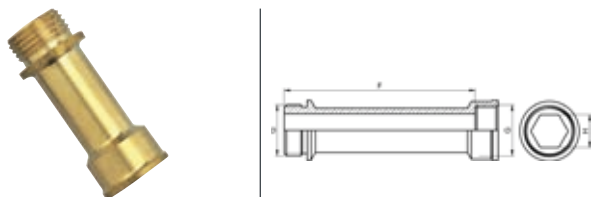

| Wymiary | Kod produktu | H | Opak. |
|---------|--------------|-----|-------|
| 100-1/2 | 1987 | H13 | 2 |
| 100-3/4 | 1997 | H17 | 2 |
| 75-1/2 | 1985 | H13 | 2 |
| 75-3/4 | 1995 | H17 | 2 |
| 50-3/8 | 1972 | H10 | 10 |
| 50-1/2 | 1982 | H13 | 10 |
| 50-3/4 | 1992 | H17 | 2 |
| 25-3/8 | 1969 | H10 | 2 |
| 25-1/2 | 1979 | H13 | 2 |
| 25-3/4 | 1989 | H17 | 2 |
| 25-1/2 | 2039 | - | 2 |
| 25-3/4 | 2049 | - | 2 |
| 50-1/2 | 2042 | - | 2 |
| 50-3/4 | 2052 | - | 2 |

PRZEDŁUŻKA GWINT ZEWNĘTRZNY WEWNĘTRZNY

8446LC

krótki gwint – surowy mosiądz

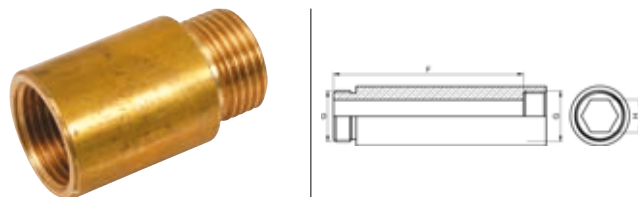

| Wymiary | Kod produktu | F | H | Opak. |
|---------|--------------|-----|------|-------|
| 15-2,5 | 2070 | 50 | H 17 | 2 |
| 22-3 | 2071 | 75 | H 17 | 2 |
| 25-3/8 | 2061 | 25 | H 10 | 2 |
| 25-1/2 | 2065 | 25 | H 13 | 2 |
| 25-3/4 | 2069 | 25 | H 17 | 2 |
| 28-3 | 2072 | 100 | H 17 | 2 |
| 50-3/8 | 2062 | 50 | H 10 | 10 |
| 50-1/2 | 2066 | 50 | H 13 | 10 |
| 75-1/2 | 2067 | 75 | H 13 | 2 |
| 100-1/2 | 2068 | 100 | H 13 | 2 |

PRZEDŁUŻKA GWINT ZEWNĘTRZNY WEWNĘTRZNY

8446LCP

krótki gwint – polerowany mosiądz

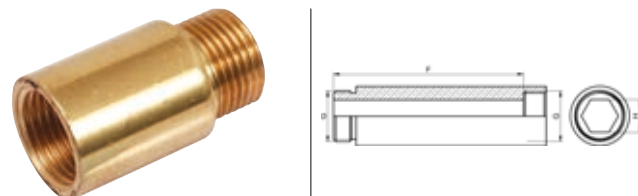

| Wymiary | Kod produktu | F | H | Opak. |
|---------|--------------|---|---|-------|
| 35-3 | 2077 | - | - | 2 |
| 42-4 | 2078 | - | - | 2 |
| 54-4 | 2082 | - | - | 2 |

PRZEDŁUŻKA GWINT ZEWNĘTRZNY WEWNĘTRZNY

8446LCC

krótki gwint – chromowana

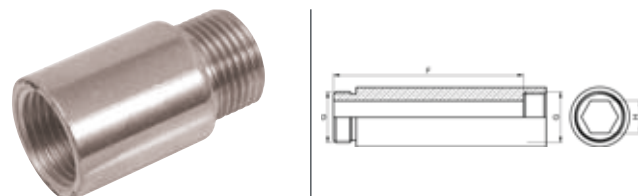

| Wymiary | Kod produktu | F | H | Opak. |
|---------|--------------|---|---|-------|
| 25-1/2 | 2089 | - | - | 2 |
| 25-3/4 | 2093 | - | - | 2 |
| 50-1/2 | 2090 | - | - | 2 |
| 50-3/4 | 2094 | - | - | 2 |

PRZEDŁUŻKA GWINT ZEWNĘTRZNY WEWNĘTRZNY

8446LLB

długi gwint – surowy mosiądz

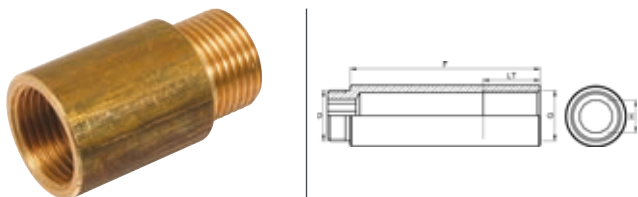

| Wymiary | Kod produktu | F | H | LT | Opak. |
|---------|--------------|-----|-------|----|-------|
| 25-3/8 | 10254 | 25 | H 10 | 15 | 2 |
| 25-1/2 | 10266 | 25 | 12p12 | 15 | 2 |
| 25-3/4 | 10278 | 25 | 12p17 | 15 | 2 |
| 50-3/8 | 10257 | 50 | H 10 | 30 | 10 |
| 50-1/2 | 10269 | 50 | 12p12 | 30 | 10 |
| 50-3/4 | 10281 | 50 | 12p17 | 30 | 2 |
| 75-1/2 | 10272 | 75 | 12p12 | 30 | 2 |
| 75-3/4 | 10284 | 75 | 12p17 | 30 | 2 |
| 100-1/2 | 10263 | 100 | 12p12 | 30 | 2 |
| 100-3/4 | 10275 | 100 | 12p17 | 30 | 2 |

PRZEDŁUŻKA GWINT ZEWNĘTRZNY WEWNĘTRZNY

8446LLBP

długi gwint – polerowany mosiądz

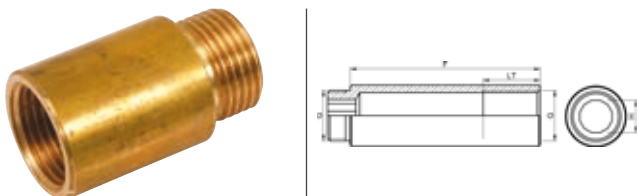

| Wymiary | Kod produktu | F | H | LT | Opak. |
|---------|--------------|----|-------|----|-------|
| 25-3/8 | 10256 | 25 | H 10 | 15 | 2 |
| 25-1/2 | 10268 | 25 | 12p12 | 15 | 2 |
| 25-3/4 | 10280 | 25 | 12p17 | 15 | 2 |
| 50-3/8 | 10259 | 50 | H 10 | 30 | 2 |
| 50-1/2 | 10271 | 50 | 12p12 | 30 | 2 |
| 50-3/4 | 10283 | 50 | 12p17 | 30 | 2 |

PRZEDŁUŻKA GWINT ZEWNĘTRZNY WEWNĘTRZNY

8446LLBC

długi gwint – chromowana

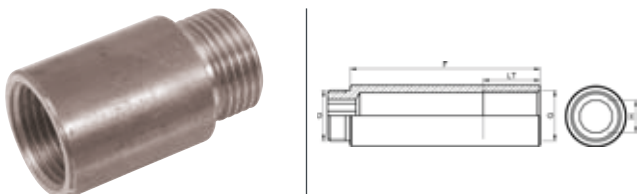

| Wymiary | Kod produktu | F | H | LT | Opak. |
|---------|--------------|----|-------|----|-------|
| 25-3/8 | 10255 | 25 | H 10 | 15 | 2 |
| 25-1/2 | 10267 | 25 | 12p12 | 15 | 2 |
| 25-3/4 | 10279 | 25 | 12p17 | 15 | 2 |
| 50-3/8 | 10258 | 50 | H 10 | 30 | 2 |
| 50-1/2 | 10270 | 50 | 12p12 | 30 | 2 |
| 50-3/4 | 10282 | 50 | 12p17 | 30 | 2 |

SZEŚCIOKĄTNA NAKRĘTKA OPOROWA

8360L

plytka z mosiądzu

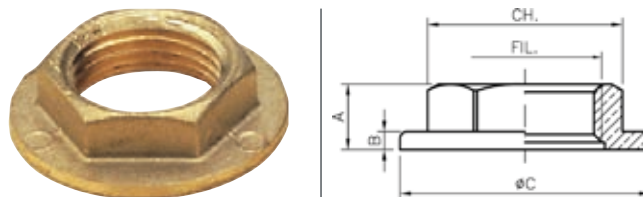

| Wymiary | Kod produktu | A | B | Opak. |
|---------|--------------|-----|-----|-------|
| 3/8 | 2157 | 8,5 | 2,5 | 10 |
| 1/2 | 2158 | 9 | 2,5 | 10 |
| 3/4 | 2159 | 9,5 | 3 | 10 |
| 1" | 2160 | - | - | 10 |
| 1*1/4 | 2161 | - | - | 5 |
| 1*1/2 | 2162 | - | - | 5 |

SZEŚCIOKĄTNA NAKRĘTKA OPOROWA

8360P

plytka z tworzywa sztucznego



| Wymiary | Kod produktu | Opak. |
|---------|--------------|-------|
| 1/2 | 2932 | 10 |

SZEŚCIOKĄTNA NAKRĘTKA OPOROWA

8360



| Wymiary | Kod produktu | Opak. |
|---------|--------------|-------|
| 1/4 | 2147 | 10 |
| 3/8 | 2149 | 10 |
| 1/2 | E122053001 | 10 |
| 3/4 | E122054001 | 10 |
| 1" | 2153 | 10 |
| 1*1/4 | 2154 | 5 |
| 1*1/2 | 2155 | 5 |

ZŁĄCZKI SUDO Z BRĄZU DO LUTOWANIA

KOLANO 90° LUT GWINT WEWNĘTRZNY

90GCU / 4090G



| Wymiary | Kod produktu | Opak. |
|----------|--------------|-------|
| 12-3/8 | 0901231-01 | 10 |
| 12-1/2 | 0901241-01 | 10 |
| 10-3/8 | 0901031-01 | 10 |
| 15-3/8 | 0901531-01 | 10 |
| 15-1/2 | 0901541-01 | 25 |
| 15-3/4 | 0901561-01 | 25 |
| 18-1/2 | 0901841-01 | 10 |
| 18-3/4 | 090186-01 | 1 |
| 22-1/2 | 090224-01 | 10 |
| 22-3/4 | 0902261-01 | 10 |
| 22-1" | 090228-01 | 10 |
| 28-3/4 | 090286-01 | 10 |
| 28-1" | 090288-01 | 10 |
| 35-1 1/4 | 090360-01 | 1 |

KOLANO 90° LUT GWINT ZEWNĘTRZNY

92GCU / 4092G



| Wymiary | Kod produktu | Opak. |
|---------|--------------|-------|
| 12-3/8 | 0921231-01 | 10 |
| 12-1/2 | 0921241-01 | 10 |
| 15-3/8 | 092153-01 | 10 |
| 15-3/4 | 092156-01 | 10 |
| 15-1/2 | 092154-01 | 25 |
| 18-1/2 | 092184-01 | 10 |
| 18-3/4 | 092186-01 | 10 |
| 22-1/2 | 092224-01 | 10 |
| 22-3/4 | 092226-01 | 10 |
| 22-1" | 092228-01 | 10 |
| 28-3/4 | 092286-01 | 10 |
| 28-1" | 092288-01 | 10 |

KOLANO WYDŁUŻONE LUT GWINT WEWNĘTRZNY

90GLCU / 4090GL



| Wymiary | Kod produktu | Opak. |
|---------|--------------|-------|
| 15-1/2 | 0906541-01 | 10 |

ŚRUBUNEK KĄTOWY LUT GWINT WEWNĘTRZNY

96GCU / 4096G



| Wymiary | Kod produktu | Opak. |
|---------|--------------|-------|
| 15-1/2 | 096154-01 | 10 |
| 22-3/4 | 0962261-01 | 10 |
| 28-1" | 0962881-01 | 5 |

ŚRUBUNEK KĄTOWY LUT GWINT ZEWNĘTRZNY

98GCU / 4098G

owalna uszczelka klinowa



| Wymiary | Kod produktu | Opak. |
|----------|--------------|-------|
| 15-1/2 | 098154-01 | 10 |
| 18-1/2 | 0981841-01 | 10 |
| 18-3/4 | 0981861-01 | 10 |
| 22-3/4 | 0982261-01 | 10 |
| 28-1" | 0982881-01 | 5 |
| 35-1 1/4 | 098360-01 | 1 |

TRÓJNIK LUT GWINT WEWNĘTRZNY LUT

130GCU / 4130G



| Wymiary | Kod produktu | Opak. |
|---------|--------------|-------|
| 10-3/8 | 130103-01 | 10 |
| 12-3/8 | 1301231-01 | 10 |
| 12-1/2 | 1301241-01 | 10 |
| 15-3/8 | 1301531-01 | 10 |
| 15-1/2 | 1301551-01 | 25 |
| 18-3/4 | 130186-01 | 10 |
| 18-1/2 | 1301841-01 | 10 |
| 22-3/8 | 1302231-01 | 10 |
| 22-1/2 | 130224-01 | 10 |
| 22-3/4 | 130226-01 | 10 |
| 28-1/2 | 130284-01 | 10 |
| 35-1/2 | 130354-01 | 1 |

NYPEL REDUKCYJNY LUT GWINT ZEWNĘTRZNY

243GCU / 4243G



| Wymiary | Kod produktu | Opak. |
|----------|--------------|-------|
| 10-3/8 | 2431032-01 | 10 |
| 10-1/2 | 2431041-01 | 10 |
| 12-3/8 | 2431232-01 | 10 |
| 12-1/2 | 2431242-01 | 10 |
| 15-3/8 | 2431532-01 | 25 |
| 15-3/4 | 2431561-01 | 25 |
| 15-1/2 | 2431542-01 | 25 |
| 18-1/2 | 2431842-01 | 10 |
| 18-3/4 | 2431861-01 | 10 |
| 22-1/2 | 243224-01 | 10 |
| 22-3/4 | 2432261-01 | 10 |
| 22-1" | 243228-01 | 10 |
| 28-3/4 | 243286-01 | 10 |
| 28-1" | 2432881-01 | 10 |
| 35-1" | 243358-01 | 10 |
| 35-1"1/4 | 243360-01 | 10 |
| 35-1"1/2 | 243362-01 | 10 |
| 42-1"1/4 | 243430-01 | 1 |
| 42-1"1/2 | 243432-01 | 10 |
| 42-2" | 243436-01 | 1 |
| 54-2" | 243556-01 | 1 |
| 76-2"1/2 | 243780-01 | 1 |
| 76-3 | 243784-01 | 1 |
| 89-3 | 243824-01 | 1 |
| 108-4 | 243882-01 | 1 |

MUFA REDUKCYJNA LUT GWINT WEWNĘTRZNY

270GCU / 4270G



| Wymiary | Kod produktu | Opak. |
|----------|--------------|-------|
| 10-3/8 | 2701031-01 | 10 |
| 10-1/2 | 2701041-01 | 10 |
| 12-3/8 | 2701231-01 | 10 |
| 12-1/2 | 2701241-01 | 10 |
| 15-3/8 | 2701531-01 | 25 |
| 15-1/2 | 2701541-01 | 25 |
| 15-3/4 | 2701561-01 | 25 |
| 18-1/2 | 2701841-01 | 10 |
| 18-3/4 | 2701861-01 | 10 |
| 22-1/2 | 270224-01 | 10 |
| 22-3/4 | 2702261-01 | 10 |
| 22-1" | 270228-01 | 10 |
| 28-1/2 | 270284-01 | 10 |
| 28-3/4 | 270286-01 | 10 |
| 28-1" | 2702881-01 | 10 |
| 28-1*1/4 | 270290-01 | 10 |
| 35-1" | 270358-01 | 10 |
| 35-1*1/4 | 270360-01 | 10 |
| 42-1*1/4 | 270430-01 | 1 |
| 42-1*1/2 | 270432-01 | 1 |
| 54-1*1/2 | 270552-01 | 1 |
| 64-2*1/2 | 270660-01 | 1 |
| 76-2*1/2 | 270780-01 | 1 |
| 89-3" | 270824-01 | 1 |

ŚRUBUNEK INSTALACJI GRZEWZYCH LUT WEWNĘTRZNY

3341GCU / 4341G

uszczelnienie na stożek – lut wewnętrzny – gwint zewnętrzny



| Wymiary | Kod produktu | Opak. |
|----------|--------------|-------|
| 12-3/8 | 3421231-01 | 10 |
| 12-1/2 | 3421241-01 | 10 |
| 15-1/2 | 3421541-01 | 10 |
| 18-1/2 | 3421841-01 | 10 |
| 18-3/4 | 3421861-01 | 10 |
| 22-3/4 | 3422261-01 | 10 |
| 22-1" | 3422281-01 | 1 |
| 28-1" | 3422881-01 | 5 |
| 42-1*1/2 | 342432-01 | 5 |

ŚRUBUNEK LUT WEWNĘTRZNY

340CU / 4340

uszczelnienie na stożek – lut wewnętrzny



| Wymiary | Kod produktu | Opak. |
|---------|--------------|-------|
| 12 | 3400121 | 10 |
| 15 | 3400151 | 10 |
| 18 | 3400181 | 10 |
| 22 | 3400221 | 10 |
| 28 | 3400281 | 5 |
| 35 | 340035 | 1 |

ŚRUBUNEK INSTALACJI GRZEWCZYCH LUT I GWINT WEWNĘTRZNY

340GCU / 4340G

okrągła uszczelka - lut wewnętrzny – gwint wewnętrzny



| Wymiary | Kod produktu | Opak. |
|----------|--------------|-------|
| 12-3/8 | 3401231-01 | 10 |
| 12-1/2 | 3401241-01 | 10 |
| 15-1/2 | 3401541-01 | 10 |
| 15-3/4 | 340156-01 | 10 |
| 18-1/2 | 3401841-01 | 10 |
| 18-3/4 | 3401861-01 | 10 |
| 22-3/4 | 3402261-01 | 10 |
| 22-1" | 3402281-01 | 10 |
| 28-1" | 3402881-01 | 1 |
| 28-1*1/4 | 3402901-01 | 1 |
| 35-1*1/4 | 3403601-01 | 5 |
| 42-1*1/2 | 3404321-01 | 5 |
| 54-2" | 3405521-01 | 1 |

KOLANO Z ŁAPAMI

471GCU / 4471G

montaż trzema wkrętami



| Wymiary | Kod produktu | Opak. |
|---------|--------------|-------|
| 12-1/2 | 471124-01 | 10 |
| 15-1/2 | 471154-01 | 25 |
| 18-1/2 | 471184-01 | 10 |
| 18-3/4 | 471186-01 | 10 |
| 22-1/2 | 471224-01 | 10 |
| 22-3/4 | 471226-01 | 10 |

KOLANO Z ŁAPAMI

472GCU / 4472G

montaż dwoma wkrętami



| Wymiary | Kod produktu | Opak. |
|---------|--------------|-------|
| 12-1/2 | 472124-01 | 10 |
| 15-1/2 | 472154-01 | 25 |
| 18-1/2 | 472184-01 | 10 |
| 18-3/4 | 472186-01 | 10 |
| 22-3/4 | 472226-01 | 10 |

ŁĄCZNIK LUT ZEWNĘTRZNY WEWNĘTRZNY

4246GCU



| Wymiary | Kod produktu | Opak. |
|---------|--------------|-------|
| 15-3/8 | 4246153-01 | 25 |
| 15-1/2 | 4246154-01 | 25 |
| 18-1/2 | 4246184-01 | 10 |
| 22-1/2 | 4246224-01 | 10 |
| 22-3/4 | 4246226-01 | 10 |

ŁĄCZNIK LUT WEWNĘTRZNY

4340GCU

okrągła uszczelka stożkowa – 3 części



| Wymiary | Kod produktu | Opak. |
|---------|--------------|-------|
| 15-1/2 | 4340154-01 | 10 |
| 18-3/4 | 4340186-01 | 10 |
| 22-3/4 | 4340226-01 | 10 |
| 22-1" | 4340228-01 | 10 |
| 28-1" | 4340288-01 | 1 |

ZŁĄCZKI TRADYCYJNE

Aksesoria SUDO

AKCESORIA SUDO

USZCZELKA PŁASKA

8361

do złączek



| Wymiary | Kod produktu | Opak. |
|-------------------|--------------|-------|
| 3/8-15-10-1,5 | 304 | 10 |
| 1/2-18-10-1,5 | 305 | 10 |
| 1/2-18-14-1,5 | 3116 | 10 |
| 5/8-20,5-14-1,5 | 3117 | 10 |
| 3/4-24-14-1,5 | 306 | 10 |
| 3/4-24-18-1,5 | 3118 | 10 |
| 7/8-26-21-1,5 | 3119 | 10 |
| 1"-30-24-1,5 | 3120 | 10 |
| 1*1/4-38,5-30-1,5 | 308 | 10 |
| 2"-55-42-1,5 | 3121 | 10 |

USZCZELKA PŁASKA

8362



| Wymiary | Kod produktu | Opak. |
|---------|--------------|-------|
| 3/8 | 3112 | 10 |
| 3/4 | 3114 | 10 |
| 1/4 | 3111 | 10 |
| 1/2 | 3113 | 10 |
| 1" | 3115 | 10 |

LUT MIĘKKKI SZPULKA BIAŁA 250G

8520A

cyna 96,5 / ołów 3,5



| Wymiary | Kod produktu | Opak. |
|-------------|--------------|-------|
| 20/10 (2mm) | 32020 | 12 |
| 20/10 (2mm) | 398521 | 12 |

LUT TWARDY 25 SZTUK

8520C

lut twardy 40% srebra, 25 drutów 2mm, długość 500mm, zgodny z ATG B 524-3 stosować obowiązkowo z topnikiem 8530



| Wymiary | Kod produktu | Opak. |
|-------------|--------------|-------|
| 20/10 (2mm) | D500001001 | 1 |

LUT MIĘKKI SZPULKA ZIELONA 250G

8520CU

cyna 97 / miedź 3



| Wymiary | Kod produktu | Opak. |
|-------------|--------------|-------|
| 20/10 (2mm) | 032100 | 12 |

LUT MIĘKKI SZPULKA NIEBIESKA 250G

8520PB

cyna 50 / ołów 50, zabroniony w instalacjach sanitarnych



| Wymiary | Kod produktu | Opak. |
|-------------|--------------|-------|
| 20/10 (2mm) | 398520 | 12 |

TOPNIK WYSOKOGATUNKOWY CARBONFLUX BIAŁY

8530

do wykorzystania z lutom 8520Cu. Pudełko 350g



| Kod produktu | Opak. |
|--------------|-------|
| 398531 | 10 |

CZYŚCIK STAŁOWY

8533

12 kawałków



| Kod produktu | Opak. |
|--------------|-------|
| 398533 | 10 |

TOPNIK WYTRAWIACZ

8534

tubka 100g



| Kod produktu | Opak. |
|--------------|-------|
| 398535 | 10 |



ZŁĄCZKI DO LUTOWANIA SUDO

ZŁĄCZKI DO LUTOWANIA SUDO, MIEDZIANE



- 1 Wysokiej jakości miedź produkowana w Europie.
- 2 Logotyp SUDO – gwarancja jakości COMAP.
- 3 Oznaczenie średnicy, dla lepszej identyfikacji.

ZŁĄCZKI DO LUTOWANIA SUDO, MOSIĘŻNE I Z BRĄZU

MOSIĄDZ

- 1 Obróbka termiczna (gwintu wewnętrznego do średnicy 1 cala) dla zwiększenia trwałości.
- 2 Jakość mosiądzu odpowiada normie EN1254-1.
- 3 Oznaczenie „A” na większości złączek z mosiądzu – gwarancja jakości COMAP.

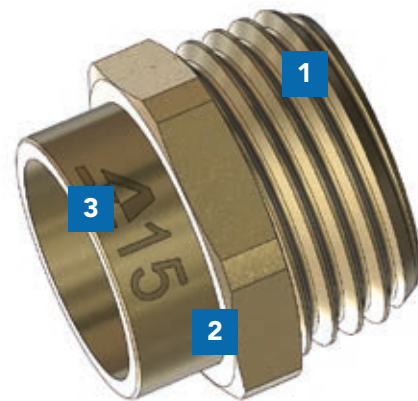

BRĄZ

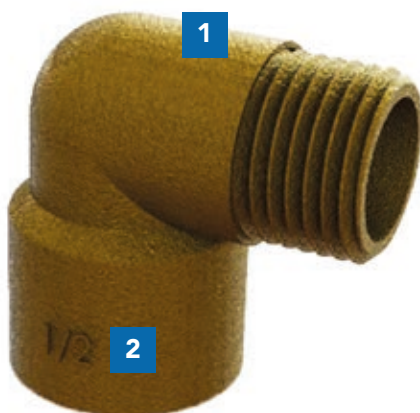

- 1 Jakość brązu odpowiada normie EN1254-1.
- 2 Oznaczenie wymiarowe dla lepszej identyfikacji złączki.

ZASTOSOWANIE

Maksymalne temperatury i ciśnienia dla złączy z miedzi.

| MIEDŹ | | | | | |
|------------|--|------------------|-----------------|---------------|----------------|
| typ lutu | przykłady lutu i spawu | temperatura [°C] | ciśnienie [bar] | | |
| | | | 6 do 34 mm | > 34 do 54 mm | > 54 do 108 mm |
| lut miękki | ołów / cyna | 30 | 16 | 16 | 10 |
| | 50/50% albo 60/40% | 65 | 10 | 10 | 6 |
| | nie używać do instalacji domowych | 110 | 6 | 6 | 6 |
| | cyna / srebro 95/5% cyna / miedź 3% maks. | 30 | 25 | 25 | 16 |
| | | 65 | 25 | 16 | 16 |
| | | 110 | 16 | 10 | 10 |
| lut twardy | srebro bez kadmu 55-40% Ag | 30 | 25 | 25 | 16 |
| | srebro z kadmem 30% albo 40% Ag | 65 | 25 | 16 | 16 |
| | miedź / fosfor 94/6% | 110 | 16 | 10 | 10 |
| | miedź / fosfor z 2% Ag 92/6/2% | | | | |

Złącza SUDO do lutowania z brązu i mosiądzu

- instalacje chłodnicze: 5°C / 10 barów
- instalacje grzewcze: 110°C / 6 barów
- instalacje sanitarne: 95°C / 16 barów
- woda albo 50% woda / 50% glikol

Rury miedziane powinny spełniać warunki normy EN 1057, Kwiecień 2006.

MONTAŻ

Do montażu naszych złączy gwintowanych, zalecamy użycie uszczelki płaskiej (zabronione jest używanie pakietu).

Średni zalecany moment obrotowy:

20 Nm < ½"

30 Nm między ½" a ¾"

40 Nm > 1"